

# ALIUS **STUDIO**



Esteticamente  
Aesthetically

**ASTRA**

# ALIUS STUDIO



## UNO STILE CHE SI FA SPAZIO

Alius è un programma versatile che prende molteplici forme, giocando con colori e materiali diversi, per offrire una vasta gamma di interpretazioni dello studio professionale. Dalle ispirazioni del passato, alla creatività del design contemporaneo, ad un'essenzialità senza tempo. E dalla sala riunito, alla zona sterilizzazione, alla sala d'attesa, sempre con uno stile coerente e affascinante. Scoprite la vostra soluzione ideale, con Alius.

## A WIDE RANGE OF SOLUTIONS

Alius is a versatile programme that takes different shapes, playing with different colours and materials, to offer a wide range of interpretations for the professional practice. From the inspirations of the past, to the creativity of the contemporary design, to a timeless essentiality. And from the practice, to the sterilization room, to the waiting room, always with a coherent and fascinating style. Discover your ideal solution, with Alius.

**2 ESSENTIAL**  
Qualità professionali ed estetiche in ogni spazio.  
*Professional and aesthetic qualities in every space.*



**24 NEO-POP**  
Funzionalità all'avanguardia con un tocco di creatività.  
*Leading-edge functionality with a touch of creativity.*

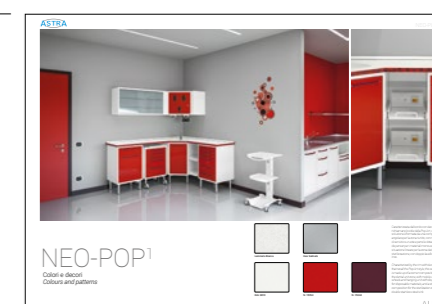

**48 URBAN-CHIC**  
Un ambiente ricco di personalità e di soluzioni.  
*A location full of personality and solutions.*



**72 GUIDA TECNICA**  
Tutte le informazioni per gli addetti ai lavori.  
*All the information for specialists.*



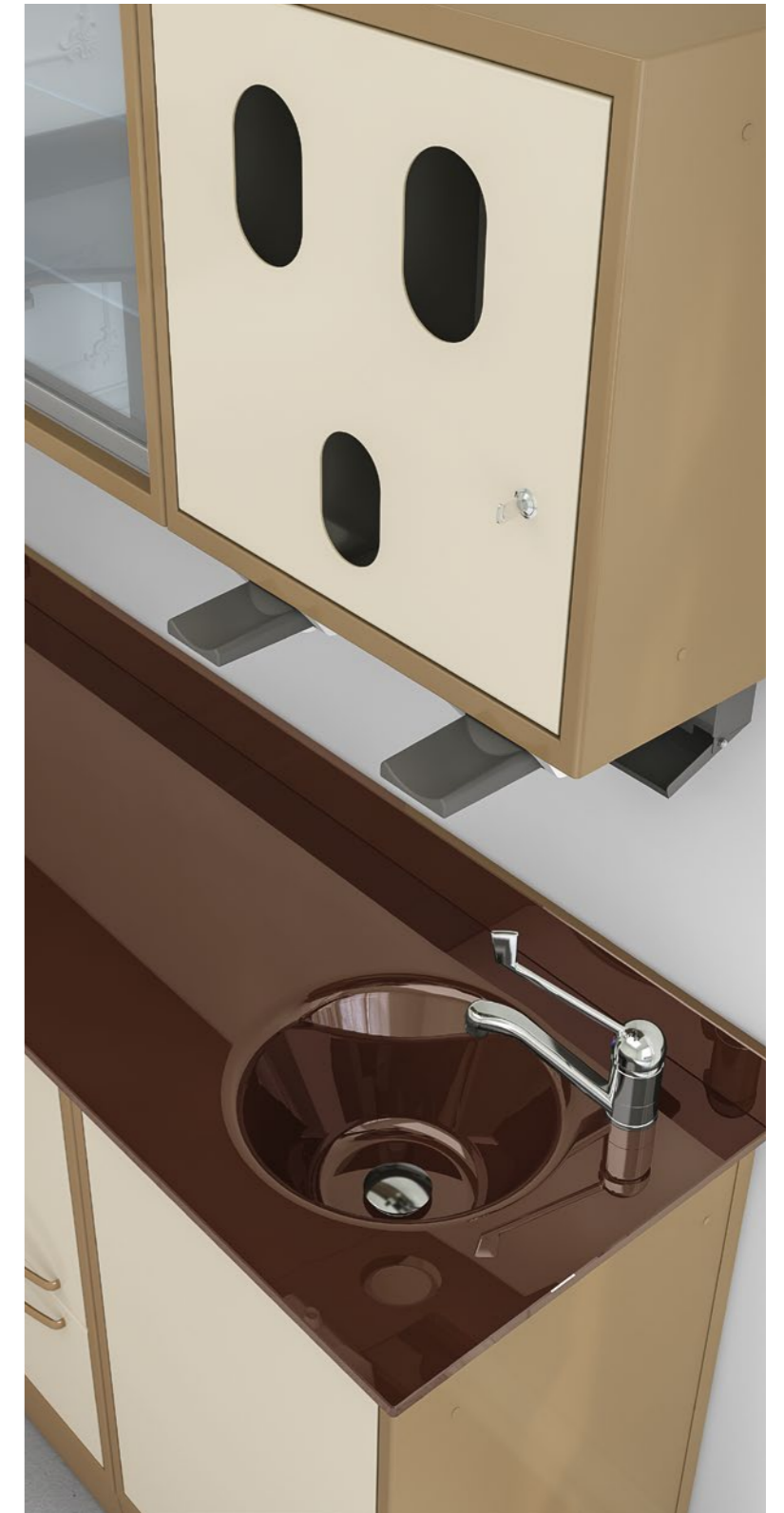

# ESSENTIAL<sup>1</sup>

Classico contemporaneo  
Contemporary classic



LAG 16

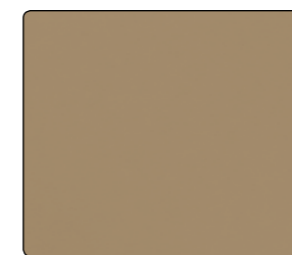

N. 15456



N. 14604

Un angolo dedicato alla professionalità ed alla funzionalità, con un'eleganza che va oltre le mode effimere. I top in vetro laccato cioccolato, si abbinano ai colori classici della base a terra, con mobile di servizio integrato, e del pensile con dispenser per materiali monouso. La vasca circolare, realizzata in fusione nel top in vetro, è dotata di miscelatore con leva clinica e piletta scarico libero.

*A corner dedicated to the professionalism and functionality, with an elegance that goes beyond the passing trends. The lacquered glass tops in chocolate colour match the classical colours of the flooring unit, with mobile unit and of the hanging unit with dispenser for disposable materials. The circular sink, made through melting in the glass top, is equipped with mixer with clinical lever and free sink drain.*



La composizione angolare utilizza al meglio lo spazio nello studio, anche grazie a soluzioni come il supporto tastiera estraibile e il supporto sottopiano per il PC.

*The corner composition takes advantage of the space in the practice, also thanks to solutions such as the pull-out keyboard support and the PC support under the worktop.*

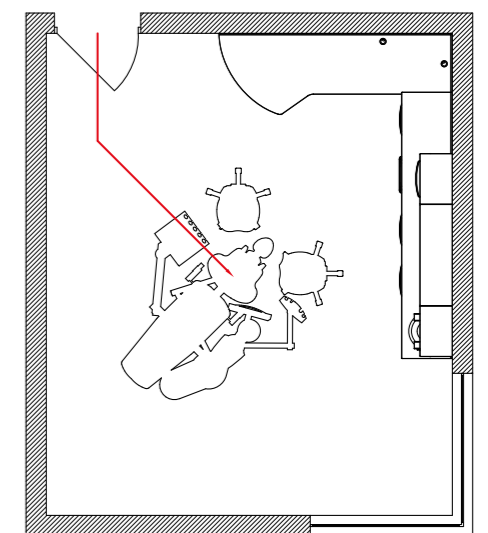



# ESSENTIAL<sup>2</sup>

Look dinamico  
Dynamic look



LAG 18



N. 15649

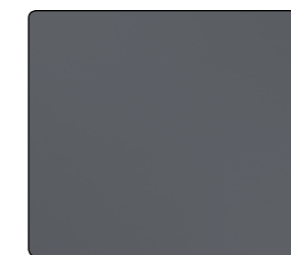

N. 15631 M

Un contrasto deciso fra il rosso e i grigi, caratterizza questa composizione lineare e compatta, con base sospesa su piedini cromati che agevolano sia i movimenti che la pulizia del pavimento. Il top e la scrivania ribassata sono in vetro laccato con vasca in fusione. Completa il tutto un pensile con dispenser per materiali monouso e un dinamico carrello di servizio in acciaio inox.

*A determined contrast between red and greys characterizes this straight and compact composition, with suspended base on chromed feet that simplify both the movements and the cleaning of the floor. The top and the lowered desk are made of lacquered glass with fused sink. The whole is completed by a hanging unit with dispenser for disposable materials and a dynamic stainless steel trolley.*



Il pensile con anta a battente è collocato in posizione strategica rispetto agli altri elementi della composizione ed al riunito dello studio.

The hanging unit with swing door is located in a clever position compared to the other elements of the composition and to the dental unit of the practice.

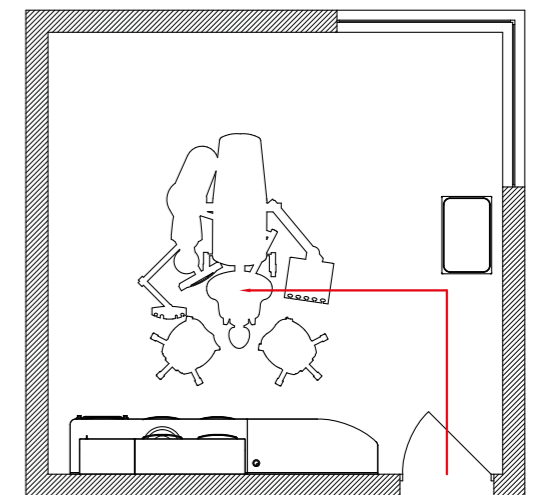



# ESSENTIAL<sup>3</sup>

Stile particolare  
*Particular style*



LEG 01

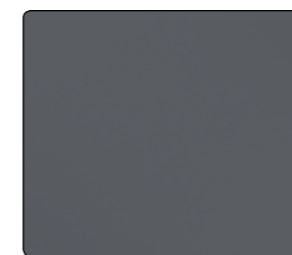

N. 15684



N. 15547

Raffinata e distintiva, questa composizione con basi sospese a parete è completata da un mobile di servizio integrato e da un carrello in acciaio inox su ruote. Il pensile con dispenser per materiali monouso, sovrasta il piano scrivania ribassato, collocato in posizione centrale rispetto agli altri elementi. La vasca circolare, posizionata a incasso sul piano in vetro, è in brillante acciaio inox.

*Refined and distinctive, this composition with suspended bases on wall is completed by a mobile unit and a stainless steel trolley. The hanging unit with dispenser for disposable materials stands above the top of the lowered desk, placed in a central position compared to the other elements. The circular sink, recessed on the glass top, is in glossy stainless steel.*



L'anta a ribalta del pensile si apre e si chiude con un semplice gesto, svelando due ripiani all'interno. Il mobile di servizio non ruba spazio nello studio ed è dotato di capienti cassetti.

The upsetable door of the hanging unit opens and closes with a simple gesture, showing two internal shelves. The mobile unit does not take too much space in the practice and it is equipped with capacious drawers.

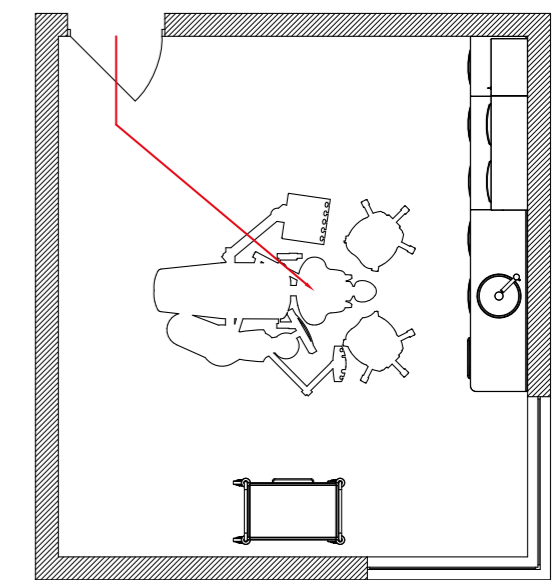





# ESSENTIAL<sup>4</sup>

Armoniosa atmosfera  
Harmonious atmosphere



LEG 23

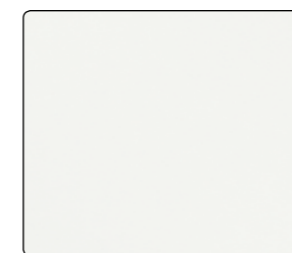

RAL 9010

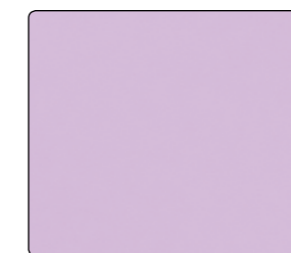

N. 11946

La purezza del bianco, abbinata alla piacevolezza del viola e del lilla, caratterizza questa composizione angolare, ricca di soluzioni per il contenimento e le attività professionali. A fianco della scrivania ribassata, trova posto uno specifico mobile porta PC. Sopra il top in vetro laccato, con vasca realizzata in fusione, si colloca un pensile con ante in vetro e dispenser per materiali monouso.

*The elegance of white, combined with the pleasantness of violet and lilac, characterizes this corner composition, full of solutions for the storage and the professional activities. Next to the lowered desk, a specific unit for PC is placed. Above the lacquered glass top with fused sink a hanging unit with glass doors and dispenser for disposable materials is located.*



Il mobile di servizio è dotato di cassetto con vassoio portastrumenti e supporto su ruote, per un facile spostamento in prossimità del riunito.

The mobile unit is equipped with tray for instruments and support on wheels, for an easy move near the dental unit.

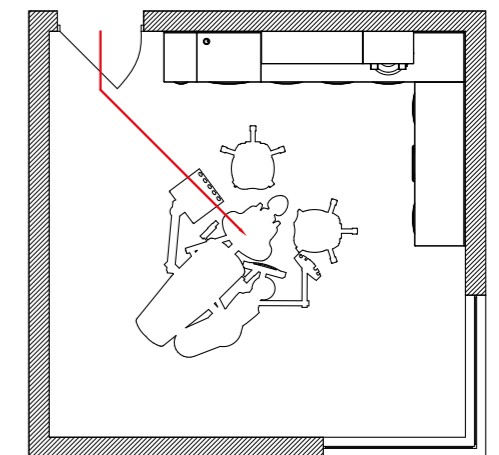



# ESSENTIAL 5

Minimale e colorato  
*Minimal and coloured*



LEG 33



RAL 9010



N. 12836 M

Caratterizzata da un'estrema linearità, ma al tempo stesso ravvivata dall'utilizzo di un colore vivace in contrasto con il bianco, questa composizione si suddivide fra la scrivania con cassetteria da un lato e una base a terra con vano tecnico, dotato di anta a scomparsa, due vasche realizzate a fusione nel piano e pensile per materiali.

*Characterized by an extreme linearity, but at the same time revived by the use of a lively colour in contrast with white, this composition is divided between the desk with drawer unit on one side and a flooring unit with technical compartment on the other, equipped with rollaway door, two fused sinks and hanging unit for materials.*



Il cassettone, attrezzato per cartelle documenti, è uno dei molti dettagli piacevolmente funzionali, in una composizione che utilizza ottimamente lo spazio a disposizione.

*The drawer, equipped for document folders, is one of the many functional details, in a composition that takes advantage of the available space very well.*

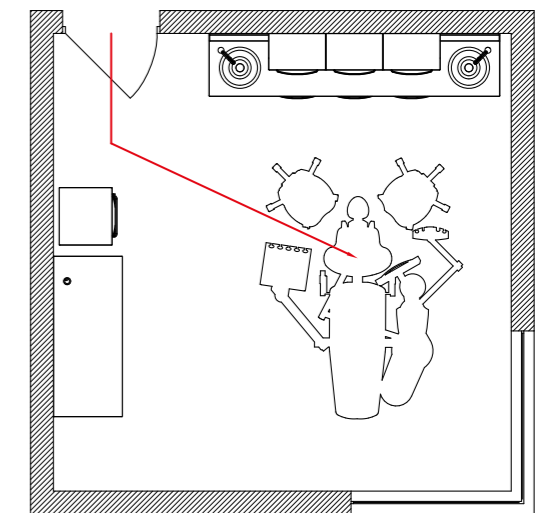





# NEO-POP<sup>1</sup>

Colori e decori  
Colours and patterns

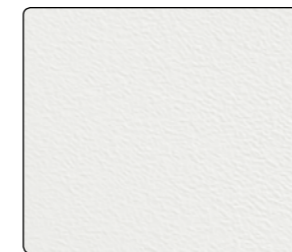

Laminato Bianco



Inox Satinato

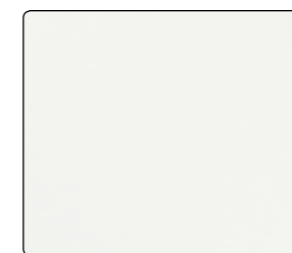

RAL 9010



N. 15354



N. 15344

Caratterizzata dal bordo con decori che richiamano lo stile della Pop Art, questa soluzione è formata da una composizione angolare per la zona riunito, con mobile di servizio su ruote e pensile dotato di dispenser per i materiali monouso, ed una situazione lineare per la zona dedicata alla sterilizzazione, con doppio livello in acciaio inox.

Characterized by the rim with decorations that recall the Pop Art style, this solution is made up of a corner composition for the dental unit zone, with mobile unit on wheels and hanging unit with dispenser for disposable materials, and a straight composition for the sterilization zone, with double stainless steel sink.



L'armadio a giorno per i vassoi di strumenti sterili affianca la base con vani per gli sterilizzatori, in un'armoniosa sintesi di estetica e funzionalità.

*The doorless cabinet for trays for sterile instruments flanks the base with compartments for sterilizers, in a harmonious synthesis of aesthetic and functionality.*

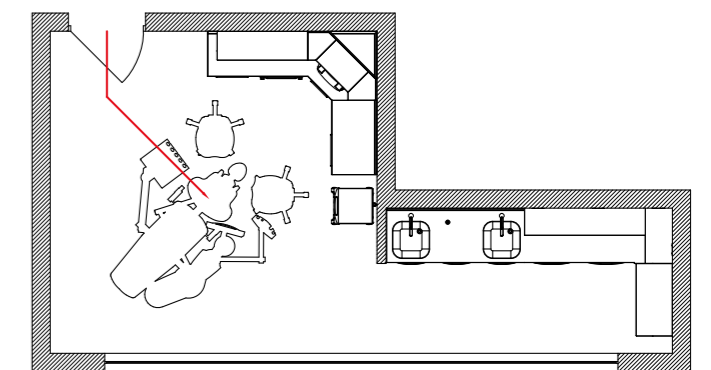



# NEO-POP<sup>2</sup>

Ispirazioni vintage  
Vintage inspirations

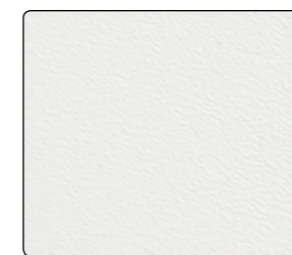

Laminato Bianco



Inox Satinato



RAL 9010

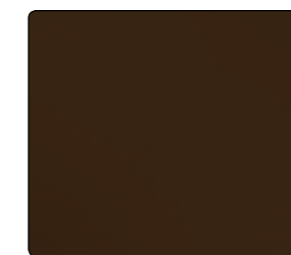

N. 15427 M

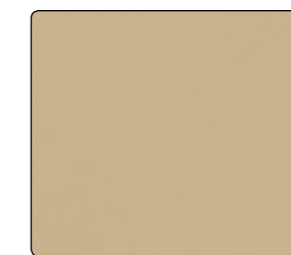

N. 15442 M

Protagonista dello studio professionale, questa composizione con basi a terra organizza e valorizza lo spazio. L'ampio armadio contenitore, dotato di ante con serratura, può essere personalizzato a seconda delle esigenze con varie tipologie di ripiani e divisori. I bordi con decori grafici contribuiscono a caratterizzare visivamente la situazione d'arredo.

*Protagonist of the professional practice, this composition with flooring bases organizes and enhances the space. The wide closet, equipped with doors with lock, can be customized with different types of shelves and divisors depending on the needs. The rims with graphic decorations contribute to characterize visually the furniture.*





L'area sterilizzazione, ispirata a principi di lineare funzionalità, garantisce un'ottimale operatività in uno spazio compatto, seguendo un itinerario razionale nelle funzioni di lavaggio e contenimento.

*The sterilization area, inspired by principles of linear functionality, guarantees an optimal efficiency in a compact space, following a rational itinerary for the functions of washing and storage.*

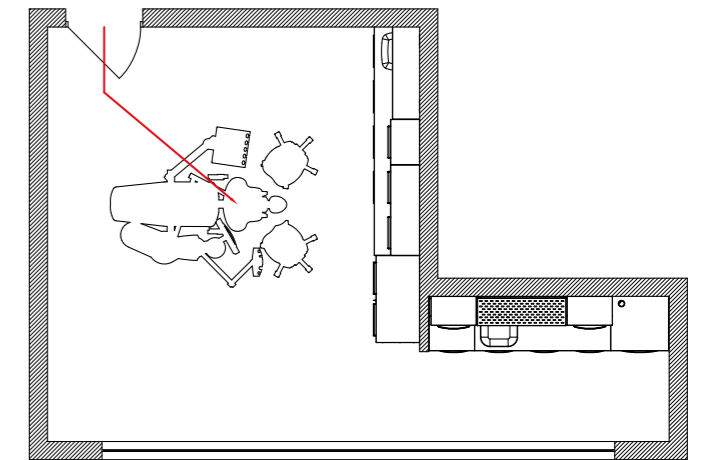





# NEO-POP<sup>3</sup>

Fresche tonalità  
*Lively shades*

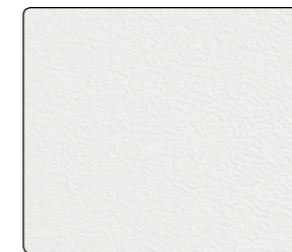

Laminato Bianco

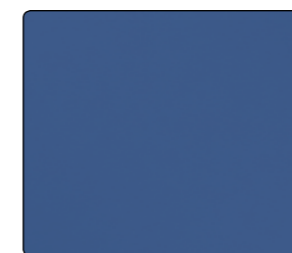

N. 11903

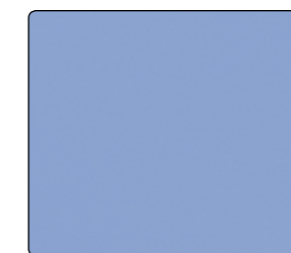

N. 12864 M

Tutta giocata sui toni dell'azzurro, del blu e del bianco questa composizione angolare, con basi sospese a parete che facilitano i movimenti e la pulizia del pavimento. Nell'angolo è collocato un lavello a incasso in acciaio inox, con piletta scarico libero e miscelatore elettronico. Completa il tutto un pensile con anta a ribalta e dispenser per materiali monouso.

*This corner composition is played on the shades of light blue, blue and white and it has suspended bases on the wall that simplify the movements and the cleaning of the floor. In the corner a recessed stainless steel sink is placed, with free sink drain and electronic mixer. The whole is completed by a hanging unit with updatable door and dispenser for disposable materials.*



Lo studio comprende un angolo attrezzato con box dotato di sistema di aspirazione per le polveri, illuminazione interna e vetro di protezione temperato.

*The practice includes a corner equipped with box with suction system for powders, internal lighting and screen protection made of lacquered glass.*

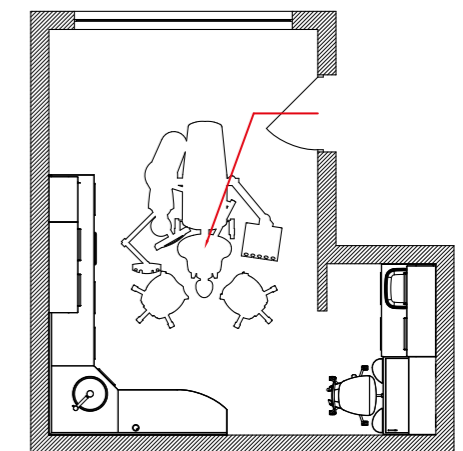



# NEO-POP<sup>4</sup>

Spazio ottimale  
*Optimal space*

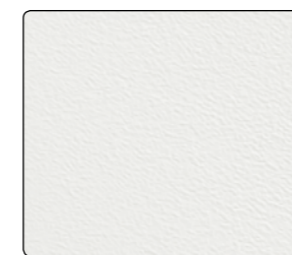

Laminato Bianco



Inox Satinato

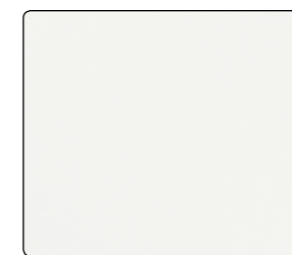

RAL 9010



N. 15286



Cromo Lucido

Una composizione che sfrutta lo spazio disponibile al millimetro, nel segno della funzionalità e dell'essenzialità, senza trascurare l'estetica grazie al decoro dei bordi. Sotto la vasca a incasso nell'angolo, un vano con anta ribaltabile, attrezzato con cesto in metallo cromato, offre un pratico spazio per il contenimento.

*A composition that takes advantage of the whole available space, as a sign of functionality and essentiality, without omit aesthetic, thanks to the decorations on the rims. Under the recessed sink on the corner, a compartment with upsetable door, equipped with chromed metal basket, offers an useful space for storage.*



Nella zona per la sterilizzazione, il cartone portarifiuti è collocato in un apposito vano dotato di anta, accessibile attraverso una botola in acciaio inox, per una massima praticità.

*In the sterilization zone, the cardboard container for garbage is placed in a specific compartment equipped with door, accessible through a stainless steel chute, for the best practicality.*

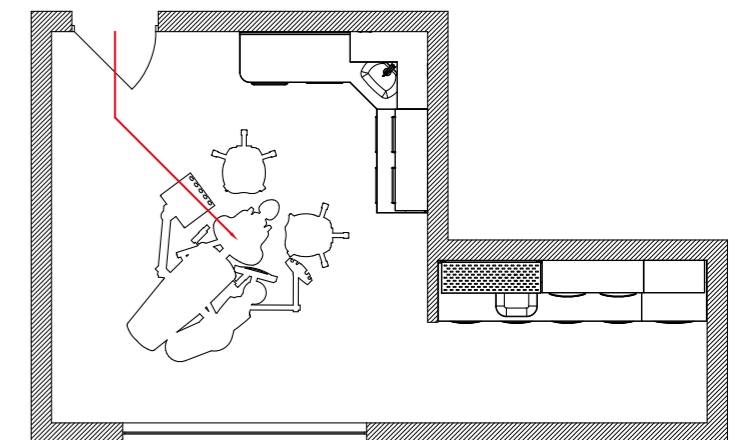





# NEO-POP<sup>5</sup>

Dimensione personale  
*Personal dimension*

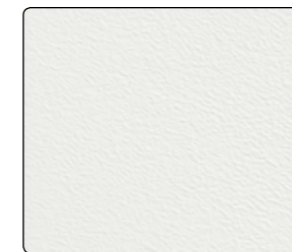

Laminato Bianco



RAL 9002



N. 12837 M

Anche uno studio di dimensioni ridotte può sviluppare ampie possibilità operative ed estetiche, grazie a soluzioni come la scrivania integrata, con porta PC sottopiano e porta tastiera estraibile. Il banco angolare è posizionato nella nicchia per i lavori di rifinitura.

*A practice with low dimension can develop a wide range of operative and aesthetic possibilities too, thanks to solutions such as the integrated desk, with PC support under the top and pull-out keyboard support. The corner bench is placed in the recess for the works of finishing.*





Il banco è dotato di ampi e funzionali cassetti, lampada regolabile e sistema di aspirazione: tutto in uno spazio minimo.

The bench is equipped with wide and functional drawers, adjustable lamp and suction system: everything in a minimum space.

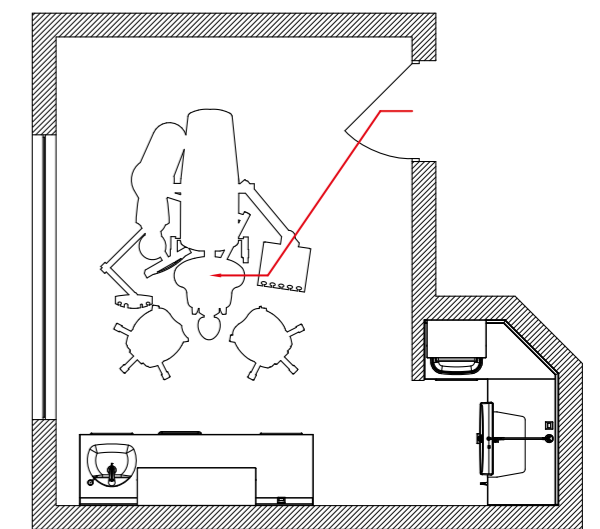



# URBAN-CHIC<sup>1</sup>

Scenario contemporaneo  
Contemporary scenery



Corian Anthracite



RAL 9010



N. 15348

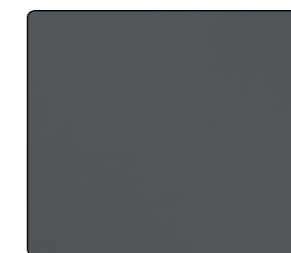

N. 15631 M

Lo studio professionale si veste di raffinati abbinamenti cromatici, in questa composizione angolare con top in Corian® con finitura pietra scura e vasche in Corian® bianco. Un'ampia dotazione di cassetti con interno attrezzato con scomparti in Pst atossico, completa la funzionalità dell'insieme.

*The professional practice dresses in refined colour combinations in this corner composition with Corian® top with dark stone finishing and white Corian® sinks. A wide number of drawers equipped with non-toxic Pst compartments on the inside completes the functionality of the whole.*



Il vano sottolavello è dotato di anta a ribalta e doppio cesto in metallo cromato. La sala d'attesa è arredata con sedie in poliuretano e acciaio cromato, disponibili anche con braccioli e cuscino in ecopelle.

*The compartment under the sink is equipped with upsettable door and double basket in chromed metal. The waiting room is furnished with chairs in polyurethane and chromed steel, available also with arm rests and synthetic leather pillow.*

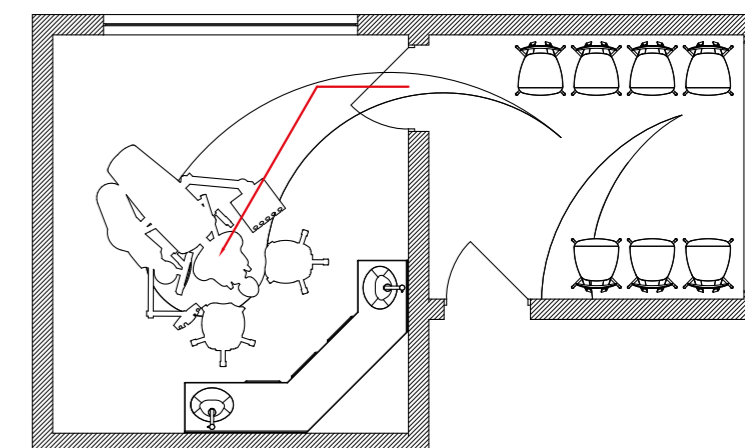





# URBAN-CHIC<sup>2</sup>

Ambiente fantastico  
Wonderful location

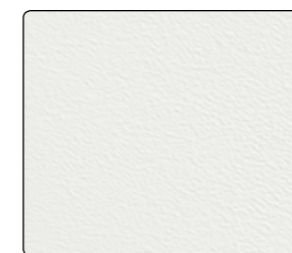

Laminato Bianco



RAL 9010

Uno spazio studiato per i più piccoli ma abitato da una grande professionalità e funzionalità. Le ante e i frontali dei cassetti sono decorati con esclusivi disegni multicolori, ispirati al tema del circo. La composizione, rialzata su piedini cromati per facilitare i movimenti e la pulizia del pavimento, è dotata di pensile con dispenser per materiali monouso e mobile di servizio integrato.

*A space studied for children but occupied by a great professionalism and functionality. The doors and front panels of the drawers are decorated with exclusive multi-coloured drawings, inspired by the circus theme. The composition, on chromed feet to simplify the movements and the cleaning of the floor, is equipped with hanging unit for disposable materials and mobile unit.*



Basta un gesto per spostare il mobile di servizio su ruote o per aprire gli ampi cassetti, dotati di scomparti in Pst atossico. In tono con la sala per il riunito, la zona d'attesa è arredata con sedie multicolori in poliuretano.

A gesture is enough to move the mobile unit on wheels or to open the wide drawers, equipped with non-toxic Pst compartments. Matching the practice, the waiting room is furnished with multi-coloured chairs in polyurethane.

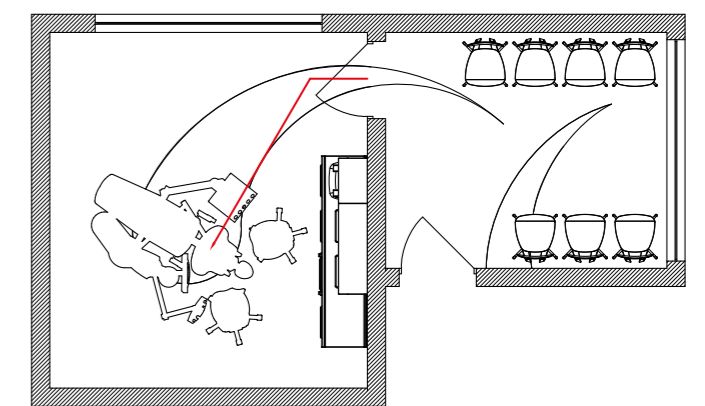



Step 2



# URBAN-CHIC<sup>3</sup>

Piacevole essenzialità  
*Pleasant essentiality*

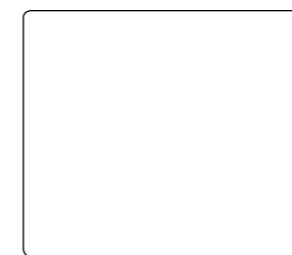

Corian Glacier White



RAL 9010

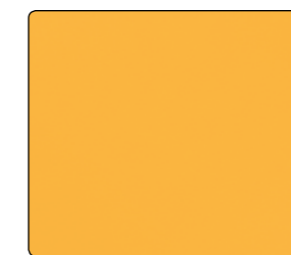

N. 11939

La purezza assoluta del bianco e la solarità del giallo, sono protagonisti di una situazione d'arredo estremamente essenziale ma con una personalità tutta propria. La composizione con basi sospese a parete, vasca realizzata in fusione nel piano in Corian® e pensile con dispenser per materiali monouso, è dotata di mobile di servizio integrato con supporto metallico su ruote.

*The absolute elegance of white and the cheerfulness of yellow are the protagonists of an extremely essential furniture, yet with an own personality. The composition with suspended units on the wall, sink made through melting to the Corian® top and hanging unit with dispenser for disposable materials, is equipped with mobile unit with metallic support on wheels.*





La scrivania, in una neutra e piacevole tonalità bianca, comprende un supporto sottopiano per il PC e un porta tastiera estraibile. La sala d'attesa è arredata con sedie multicolori, in tono con la zona riunito.

The desk, with a neutral and pleasant white shade, includes a PC support under the top and a pull-out keyboard support. The waiting room is furnished with multi-colour chairs that match the dental unit zone.

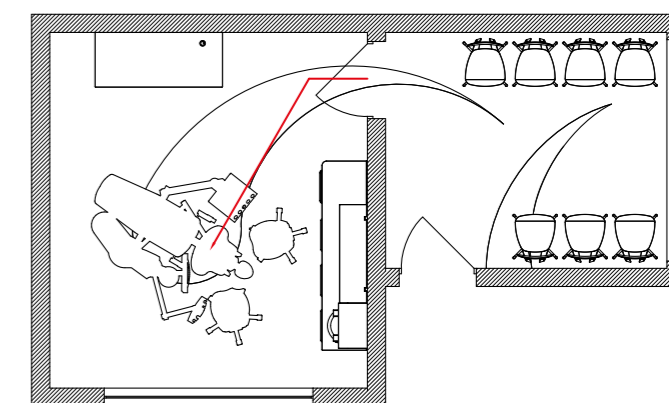



# URBAN-CHIC<sup>4</sup>

Eleganza assoluta  
*Absolute elegance*



LAG 26



RAL 9010

In equilibrio tra fantasia e professionalità, questa composizione è decorata con originali illustrazioni sul tema del circo ed offre tutte le migliori soluzioni per il contenimento, in uno spazio ottimale: dall'ampio armadio, dotato di ripiani regolabili per soddisfare ogni esigenza, al mobile di servizio integrato, con capienti cassetti.

*In balance between imagination and professionalism, this composition is furnished with original circus pictures and offers all the best solutions for storage, in an optimal space: from the wide closet, equipped with adjustable shelves to satisfy every need, to the mobile unit with capacious drawers.*



Colori accattivanti caratterizzano il piano in vetro, con vasca realizzata in fusione, e le scocche in poliuretano delle sedie, nella zona dedicata all'attesa.

*Captivating colours characterize the glass top, with fused sink, and the polyurethane shells of the chairs distinguish the waiting area.*

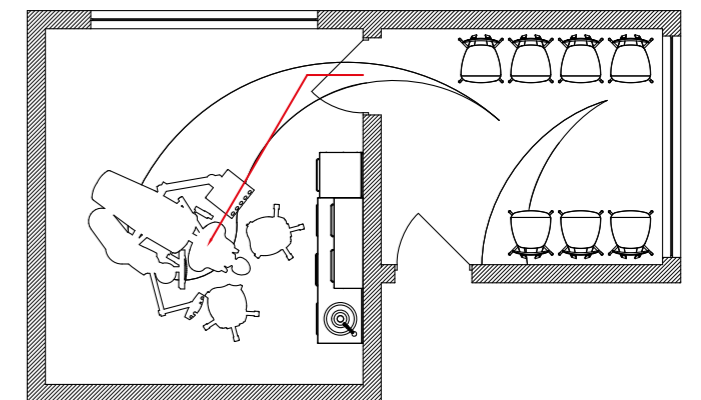



# URBAN-CHIC<sup>5</sup>

Lineare eleganza  
*Linear elegance*

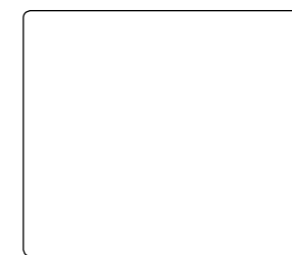

Corian Glacier White

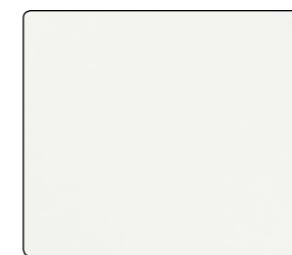

RAL 9010



N. 12838 M

Raffinato oltre il tempo e le mode, l'abbinamento fra il bianco e il blu caratterizza questa composizione lineare, con basi a terra dotate di cassetti di varie dimensioni, per soddisfare qualsiasi esigenza di contenimento. Il top e le vasche sono in Corian® bianco con miscelatori elettronici. Completano l'insieme i pensili con pratiche ante.

*Refined beyond time and trends, the combination of white and blue characterizes this straight composition, with flooring units equipped with drawers of different dimensions, to satisfy every storage need. The top and the sinks are made of white Corian® with electronic mixers. The whole is completed by hanging units with practical doors.*



Il vano sottolavello è dotato di anta a ribalta con apertura a spinta, cesto in metallo cromato e contenitore per la raccolta degli aghi e taglienti.

The compartment under the sink is equipped with upsettable door with knee opening, chromed metal basket and needles container.

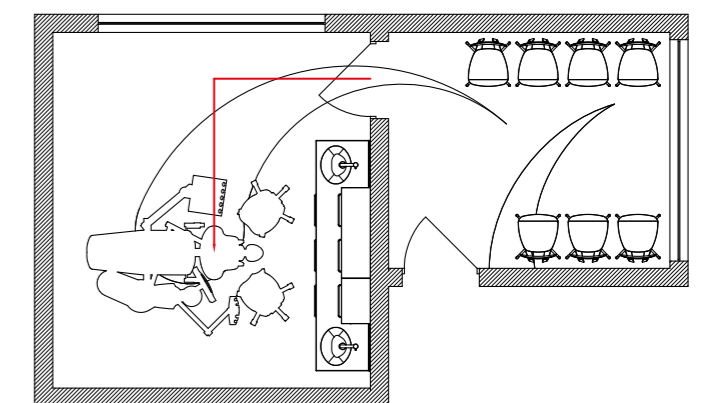

# Scheda prodotto ALIUS.

In questa scheda potrà trovare i materiali e componenti che caratterizzano questa linea prodotto, i componenti impiegati sono tutti di prima qualità e di fabbricazione italiana.

## ALIUS product sheet.

*In this product sheet you will find the materials and the elements that characterize this line of product. All the elements that have been employed are of first rate and made in Italy.*

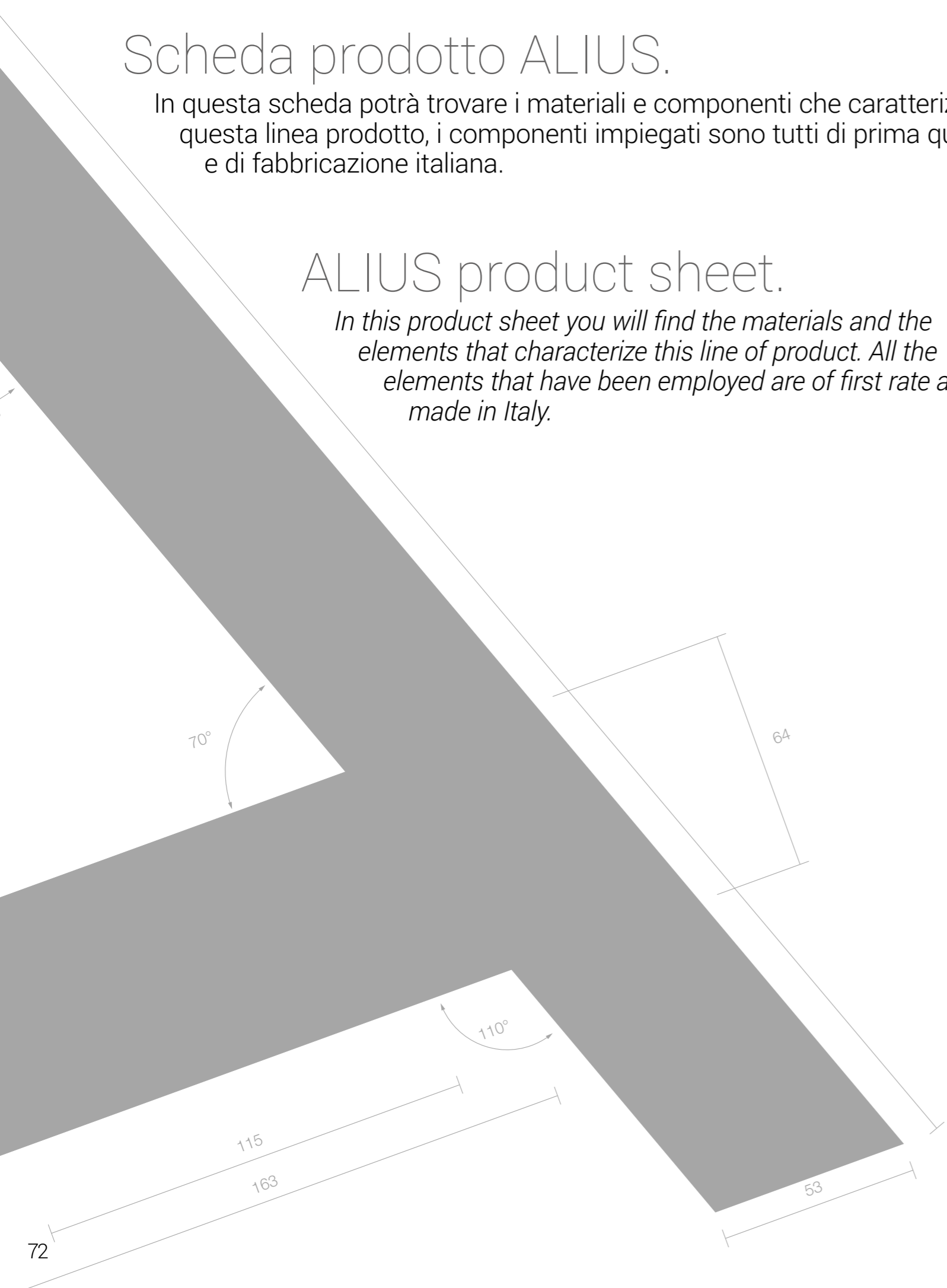

**METALLO**

"Elettrozincato" Ze25/25, prodotto piano, in nastro o lamiera con zincatura elettrolitica, un rivestimento applicato mediante elettrolisi su entrambe le superfici. Lo spessore del rivestimento è di 25µm. Il trattamento superficiale riduce il rischio di corrosione, che si verifica durante lo stoccaggio, e costituisce un idoneo supporto per il trattamento di verniciatura.

**METAL**

"Electrogalvanized" Ze25/25, produced flat, in belt or metal sheet with electrolytic galvanization, a covering applied through electrolysis on both surfaces. The thickness of the covering is 25µm. The surface treatment limits the risk of corrosion, that occurs during the storage, and represents a suitable support for the painting treatment.



**ALLUMINIO**

L'alluminio è un materiale leggero e malleabile ma molto resistente. Viene impiegato per la costruzione di bordi, maniglie e piedini. Con il trattamento di anodizzazione, l'alluminio diventa ancora più resistente ai graffi e alla corrosione.

**ALUMINIUM**

Aluminium is a light and malleable material, but it is also very resistant. It is used to produce rims, handles and feet. With the anodizing treatment, aluminium becomes even more resistant to scratches and corrosion.



**STRUTTURA**

In lamiera elettrozincata spessore 8/10 con rinforzi e parti interne spessore 10/10 e 20/10 piegata e saldata in modo da ottenere una struttura integra, gli angoli a vista sono saldati e smerigliati.

**STRUCTURE**

In electrogalvanized metal sheet, thickness 8/10 with supports and internal parts with thickness 10/10 and 20/10 bended and welded in order to obtain a complete structure. The visible corners are welded and grinded.

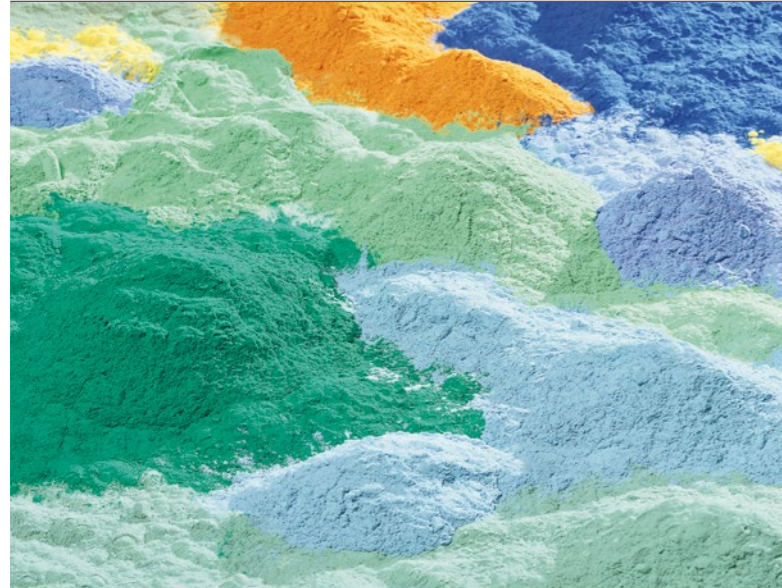

**VERNICIATURA**

Il nostro processo di verniciatura comporta il lavaggio e la sgrassatura del materiale, l'applicazione del trattamento di fosfatazione e l'utilizzo di polveri certificate di qualità ad alta temperatura e finitura in forno a 180-200°C. L'organizzazione della produzione è centrata sul costante controllo della qualità. Le vernici utilizzate sono atossiche, senza metalli pesanti e chimicamente resistenti ai raggi UV e alla corrosione.

**PAINTING**

Our painting process entails the washing and degreasing of the material, the application of the phosphate conversion coating treatment and the employment of certified and high quality powders in high temperature and finishing in furnace at 180-200°C. The organization of the production is focused on the constant control of the quality. The paints employed are non-toxic, without heavy metals, and chemically resistant to UV light and to corrosion.



**GUIDE**

Guide a scorrimento su rotelle realizzate in acciaio ad alta resistenza per supportare le più gravose condizioni di carico, portata 25Kg. Complete di accessorio di chiusura soft fissato alle guide, in chiusura il sistema aggancia il cassetto rallentando la sua corsa.

**GUIDES**

Ball-bearing slides made of high-resistance steel to support the most onerous loading conditions, payload 25Kg. Soft-closing accessory fixed to the guides; during the closing action the system hooks up the drawer slowing down its sliding.



**ANTE E FRONTALI**

Ante in metallo verniciato, tamburate con rinforzo interno per aumentare la resistenza nella parte centrale. Apertura reversibile destra e sinistra anche in fase di installazione. Ante in vetro acidato e temperato spessore 6mm con cornice perimetrale in metallo verniciato e profili interni in acciaio inox lucido. Frontali con bordi arrotondati e angoli saldati, senza fessure e spigoli vivi, verniciati anche internamente.

**DOORS AND FRONT PANELS**

Doors in painted metal, made with wooden reinforcing panels and internal support to increase the resistance in the central part. Right and left reversible opening, also in installation phase. Door in tempered and acid etched glass, thickness 6mm with frame along the perimeter in painted metal and internal profiles in glossy stainless steel. Front panels with rounded rims and welded corners, with no splits and sharp edges, painted on the inside as well.



**FONDI**

Le basi sono realizzate con fondi amovibili per facilitare la pulizia interna del mobile e accedere ai piedini di livellamento.

**BOTTOMS**

The bases are made with removable bottoms in order to ease the internal cleaning of the unit and to have access to the levelling feet.



**CASSETTI**

Cassetti in metallo verniciato di varie dimensioni a estrazione quasi totale con grande capienza di contenimento, forniti di bacinelle bianche in PST atossico.

**DRAWERS**

Drawers in painted metal, in various dimensions, almost total extraction and big capacity, equipped with white trays in non-toxic PST.



**PIEDINI**

Piedini in acciaio zincato e tecnopolimero per il livellamento delle basi e gambe, regolabili in altezza fino a 20 mm.

**FEET**

Feet in zinc-coated steel and engineer plastic for the levelling of the bases and legs, adjustable height up to 20mm.



**RUOTE**

Ruote piroettanti in gomma morbida con diametro 50-80mm con o senza freno, in colore bianco-grigio.

**WHEELS**

Castors in soft rubber with diameter 50-80mm with or without brake, in white-grey colour.



**GUARNIZIONI**

Guarnizione estrusa con mescola a base di PVC plastificato con la funzione di sigillatura delle polveri e ammortizzatore nella chiusura di cassetti ed ante.

**SEALS**

Extruded seal with blend containing plastic coated PVC to seal the powders and to amortize the closing of drawers and doors.

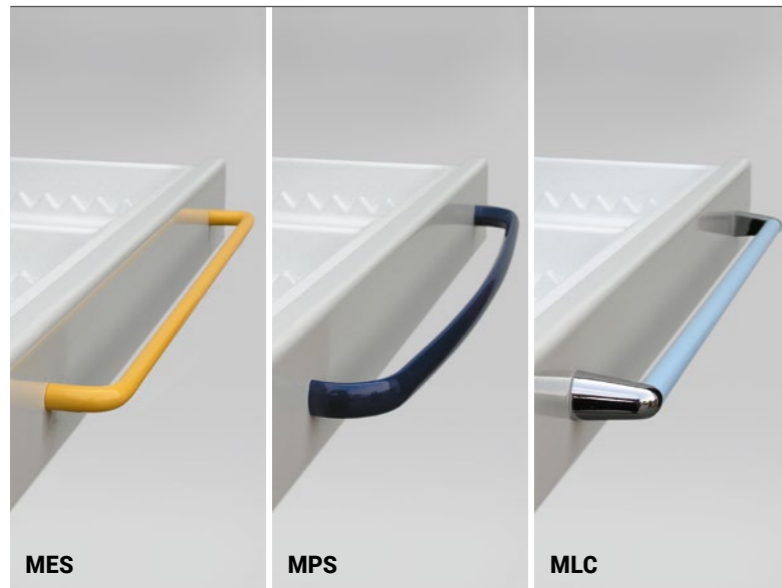

**MANIGLIE**

Maniglie in profilo di alluminio verniciato o anodizzato, disponibili 3 modelli MES, MPS, MLC. Colori di serie come da nostra scala colori riferita ai colori dei riuniti dentali dei principali produttori.

**HANDLES**

Handles in painted or anodized aluminium profile. 3 available models: MES, MPS, MLC. Colours of our colour collection, which refers to the colours of the dental units of the main manufacturers.



**ATTACCAGLIE**

Attaccaglie in ABS stampato con gancio in acciaio, regolabili in altezza e profondità. Il fissaggio del pensile viene assicurato al muro attraverso una barra reggi pensile in acciaio fissata con viti a pressione. Collaudate per sopportare fino a 65 Kg di peso.

**HANGERS**

Printed-ABS hangers with steel hook, adjustable in height and depth. The fastening of the unit is secured to the wall through a steel plank that holds the unit and which is fixed with pressure screws. Tested to bear up to 65 Kg.



**CERNIERE**

Cerniere in acciaio con riporto galvanico di rame e nichel, dotate di tre regolazioni, resistenza garantita a 120.000 cicli di apertura - chiusura. Apertura di 110° di serie e 180° per maggiore praticità.

**HINGES**

Hinges in steel with buildup of copper and nickel, equipped with three regulations. Guaranteed resistance to 120.000 opening-closing cycles. 110° opening and 180° for a greater practicality.

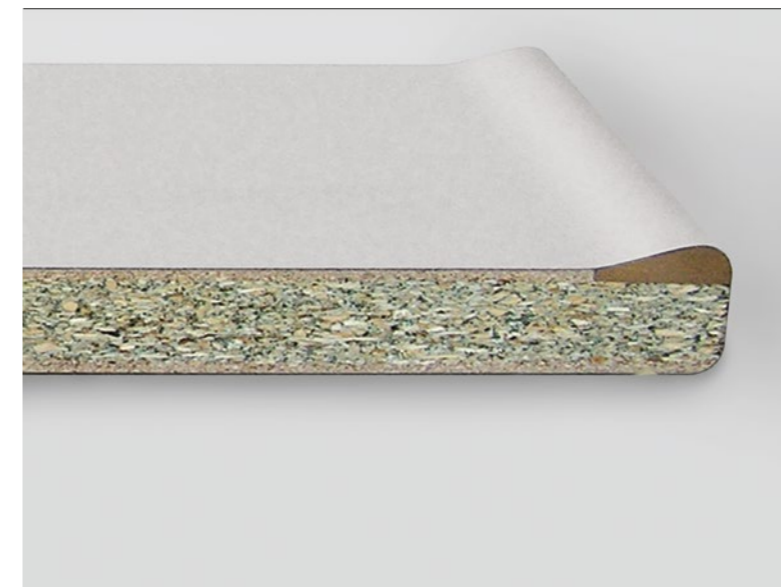

**PANNELLI**

Pannelli costituiti da particelle di legno idrorepellente di classe E1 (a bassissima emissione di formaldeide) poi rivestiti in laminato HPL antigraffio oppure con lastra in acciaio inox scotch brite o pannello in Corian®.

**PANELS**

Panels made of wood water-repellent particles of class E1 (very low emission of formaldehyde) and later covered by HPL anti-scratch laminate or by a stainless steel sheet, scotch brite of Corian® panel.



Scegli il piano di lavoro più adatto alle tue esigenze.

I nostri piani sono disponibili in materiali diversi, ognuno dei quali presenta vantaggi specifici, ma sono tutti idonei alle esigenze dello studio, della sterilizzazione e del laboratorio.

Choose the worktop that best suits your needs.

*Our tops are available in different materials, each of which has its specific advantages, but are all suitable for the needs of practice, sterilization and laboratory.*



**PIANO LAMINATO**  
Piano laminato costituito da pannelli di particelle di legno idrorepellente di classe E1 rivestito in laminato HPL antigraffio e postformato D8 anteriormente, con alzatina.

max (Lunghezza massima barra 4200x500/600 mm).

**LAMINATE TOP**  
Laminate top made of water-repellent particles of wood of class E1, covered by HPL laminate anti-scratch and frontally by postforming laminate D8, with rim.

max (Maximum plank length 4200x500/600 mm).



**AL/P500D8  
AL/P600D8**  
Piano in laminato bianco artico spessore 30 mm.

Arctic white laminate top, thickness 30 mm.



**PIANO IN STRATIFICATO AL/STRB**  
Piano di lavoro in stratificato HPL bianco di 10 mm costituito da strati di fibre cellulose impregnate con resine fenoliche termoindurenti, legate insieme da un processo di alta pressione, materiale compatto e non poroso.

max (Dimensione massima pannello 4200x1600 mm).

**PLYWOOD TOP AL/STRB**  
Worktop in HPL laminate 10 mm consisting of layers of cellulose fibers impregnated with thermosetting phenolic resins combined together by a high-pressure process. Compact and non-porous material.

max (Panel maximum dimension 4200x1600 mm).



**PIANO LAMINATO AL/P500AI - AL/P600AI**  
 Piano in laminato bianco postformato con bordo anteriore e alzatina integrata, supporto di conglomerato dello spessore di 28 mm idrorepellente e testate laterali in alluminio anodizzato.

max (Lunghezza massima barra 4200x500/600 mm).

**LAMINATE TOP AL/P500AI - AL/P600AI**  
 White postforming laminate top with frontal rim and incorporated rim, water-repellent conglomerate support thickness 28 mm, and lateral anodized aluminium extremities.

max (Maximum plank length 4200x500/600 mm).

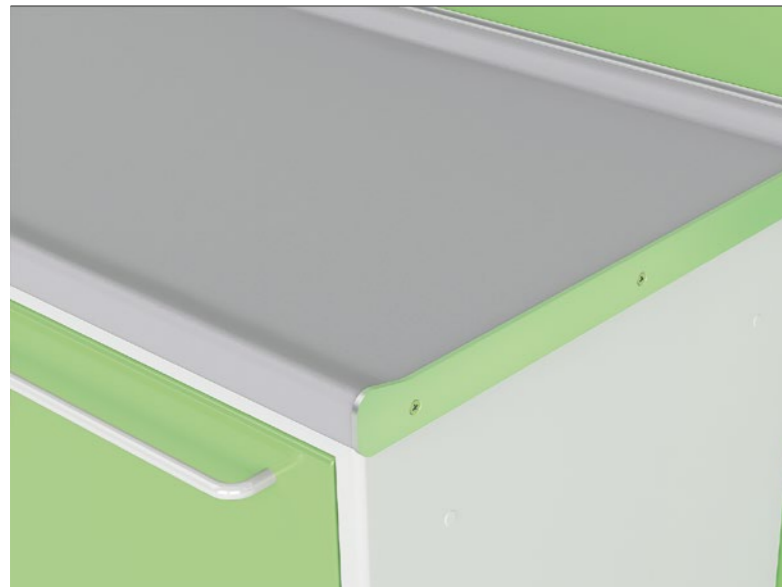

**PIANO LAMINATO AL/P500CAI**  
 Piano in laminato colorato postformato con bordo anteriore e alzatina integrata, supporto di conglomerato dello spessore di 28 mm idrorepellente e testate laterali in alluminio anodizzato.

max (Lunghezza massima barra 3050 x 500 mm).

Colori testate disponibili: Nichel perla, Cromo lucido, Nichel satinato, Brown satinato, Oro lucido.

**LAMINATE TOP AL/P500CAI**  
 Postformed coloured laminate top with frontal rim and incorporated rim, water-repellent conglomerate support thickness 28 mm, and lateral anodized aluminium extremities.

max (Maximum plank length 3050 x 500 mm).

Available colours for extremities: Pearl Nichel, Glossy Chrome, satin Nichel, Satin Brown, Gold.

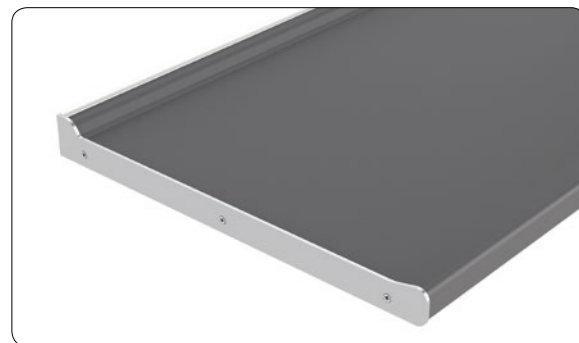

Piano in laminato colorato grigio ferro  
 Iron-grey laminate top



Piano in laminato colorato marrone carruba  
 Carob-brown laminate top



Piano in laminato colorato grigio alluminio  
 Aluminium-grey laminate top



Piano in laminato colorato nero seppia  
 Ink-black laminate top



**PIANO LAMINATO AL/PSACABS**  
 Piano in laminato HPL double face bianco/grigio con supporto di conglomerato dello spessore di 28 mm idrorepellente con bordo perimetrale in ABS in vari colori e in variante pop, il tipo di bordo crea un effetto estetico importante.

max (Dimensione massima pannello 3050x1300 mm).

**LAMINATE TOP AL/PSACABS**  
 Double-faced HPL laminate top white/grey with water-repellent conglomerate support thickness 28 mm and ABS rim along the perimeter in different colours and in the pop variation. The type of rim creates an important aesthetic effect.

max (Panel maximum dimension 3050x1300 mm).

**Laminato Bianco**  
 White laminate

**Laminato Grigio**  
 Grey laminate



Bordo/Rim Bianco



Bordo/Rim Grigio



Bordo/Rim Bianco



Bordo/Rim Grigio



Bordo/Rim Nero



Bordo/Rim Millerighe

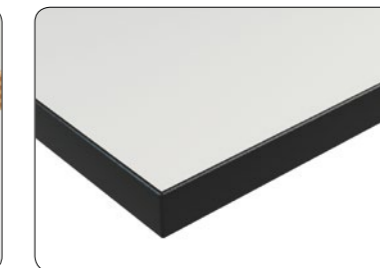

Bordo/Rim Nero



Bordo/Rim Millerighe



Bordo/Rim Pop Grigio



Bordo/Rim Pop Beige



Bordo/Rim Pop Grigio



Bordo/Rim Pop Beige



Bordo/Rim Pop Azzurro



Bordo/Rim Pop Giallo



Bordo/Rim Pop Azzurro



Bordo/Rim Pop Giallo



Bordo/Rim Pop Verde



Bordo/Rim Pop Rosso



Bordo/Rim Pop Verde



Bordo/Rim Pop Rosso



**PIANO ROVERE AL/PSACABS**

Piano in laminato HPL double face grigio/rovere con supporto di conglomerato dello spessore di 28 mm idrorepellente, la finitura superiore del legno rovere nelle sue varianti colore dona un'atmosfera più calda e naturale.

max (Dimensione massima pannello 3050 x 1300 mm).

**OAK TOP AL/PSACABS**

Double-faced HPL laminate top grey/oak with water-repellent conglomerate support thickness 28 mm. The oak wood shades offer a warmer and more natural atmosphere.

max (Panel maximum dimension 3050 x 1300 mm).



Piano laminato Rovere Iceland con bordo ABS.

Rovere Iceland laminate top with ABS rim.



Piano laminato Rovere Maul con bordo ABS.

Rovere Maul laminate top with ABS rim.



Piano laminato Rovere Valley con bordo ABS.

Rovere Valley laminate top with ABS rim.



**PIANO IN ACCIAIO INOX**

Piano in acciaio inox con supporto di conglomerato dello spessore di 28 mm rivestito da lamiera in acciaio inox AISI 304 con finitura scotch brite, spessore 1.2 mm, perfettamente inattaccabile dalle macchie, presenta caratteristiche di assoluta idoneità al trattamento igienico nella sterilizzazione e nel laboratorio.

**STAINLESS STEEL TOP**

Stainless steel top with conglomerate support thickness 28 mm, covered by AISI 304 stainless steel metal sheet with scotch brite finishing, thickness 1.2 mm. Perfectly resistant to stains, it presents features that are absolutely adequate for the hygienic treatment in the sterilization room and in the laboratory.

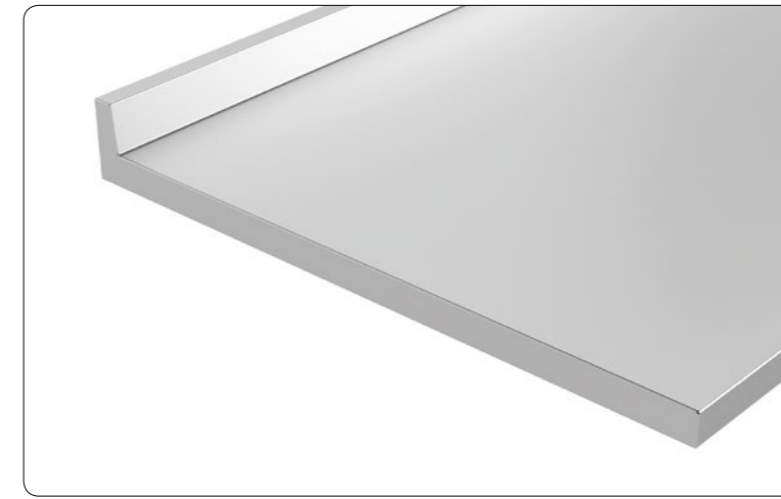

**AL/P500IN  
AL/P600IN**

Piano in acciaio inox con alzatina incorporata.

Stainless steel top with incorporated rim.

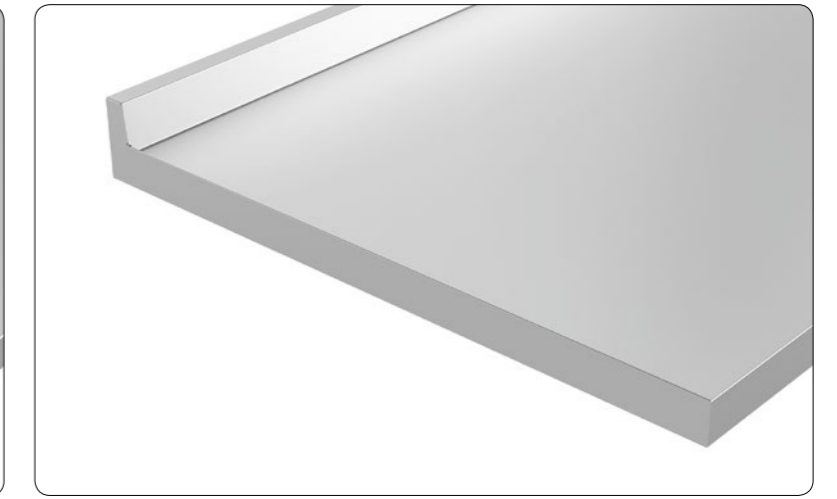

**AL/P600INBA**

Piano in acciaio inox con alzatina incorporata e bordo perimetrale antiracimazione.

Stainless steel top with incorporated rim and anti-overflow rim along the perimeter.

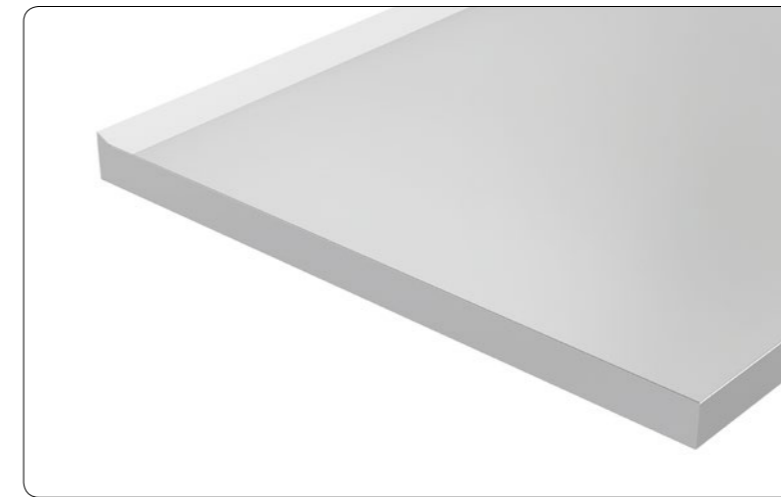

Variante con alzatina ridotta per utilizzo nelle strutture self-supporting.

Variation with reduced rim for the use in the self-supporting structures.



Su richiesta piani e vasche in inox AISI 316 con finitura scotch brite.  
AISI 316 stainless steel tops and sinks with scotch brite finishing on request.



**PIANO IN CORIAN®**  
 Piano in Corian® spessore 12, materiale non poroso, compatto in tutto il suo spessore, con superficie molto igienica, può essere costruito con giunzioni impercettibili e senza cavità capaci di trattenere lo sporco e i liquidi, alzatina posteriore incollata.

**CORIAN® TOP**  
 Corian® top thickness 12 mm. Non-porous material, compact in all its thickness, with very hygienic surface, it can be built with imperceptible connections and without cavities able to hold back filth and liquids. Rear rim glued.

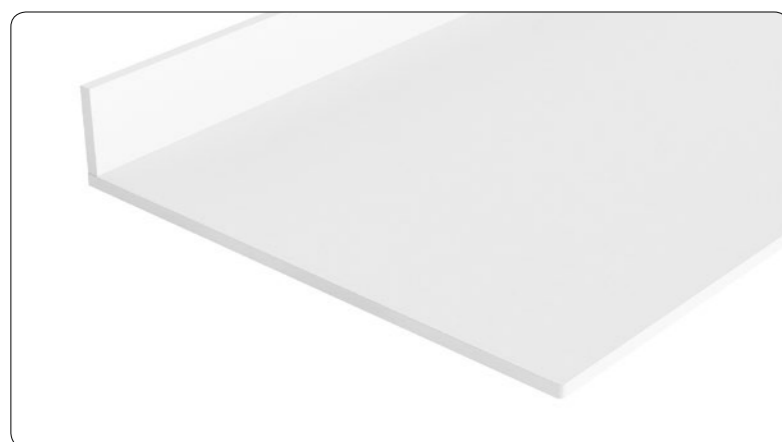

**AL/P500CO  
 AL/P600CO**  
 Piano in Corian® bianco sp. 12 con alzatina incorporata.  
 Worktop in white Corian® th. 12 with incorporated rim.

**NOTE**  
 Su richiesta altri colori serie SOLID CORIAN.  
 Other SOLID CORIAN colours available on request.



**PIANO IN CORIAN®**  
 Piano in Corian® con supporto di conglomerato dello spessore di 18 mm idrorepellente rivestito con lastra Corian® dello spessore di 12 mm, alzatina integrata con angoli interni raggiati.

**CORIAN® TOP**  
 Corian® top with water-repellent conglomerate support thickness 18 mm, covered by Corian® sheet thickness 12 mm, incorporated rim and internal corners bended.

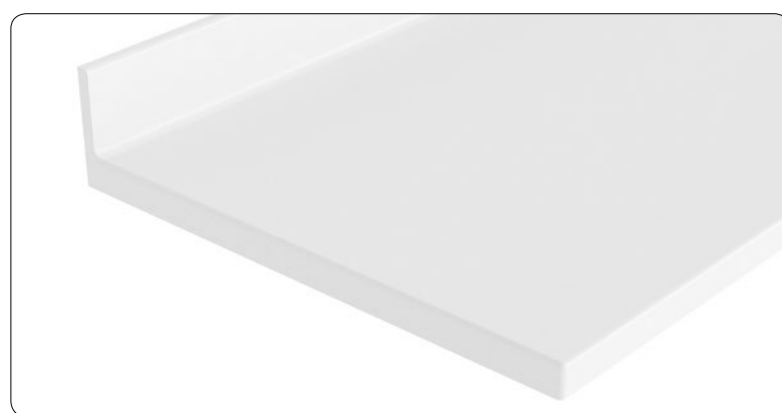

**AL/P500C03  
 AL/P600C03**  
 Piano in Corian® bianco sp. 30 con alzatina incorporata.  
 Worktop in white Corian® th. 30 with incorporated rim.

**NOTE**  
 Su richiesta altri colori serie SOLID CORIAN.  
 Other SOLID CORIAN colours available on request.



**PIANO IN VETRO**  
 Il piano in vetro è ricavato da una lastra di vetro float o extra-light di spessore 15 mm, materiale ricco di fascino, attrae per la sua brillantezza e inalterabilità, produce un esaltante effetto estetico. Il vetro è un materiale atossico, rappresenta una garanzia di igiene e di perfetta pulizia.

**GLASS TOP**  
 The glass top is obtained from a float or extra-light glass sheet thickness 15 mm. A fascinating material which attracts for its brilliance and inalterability, it produces an exciting aesthetic effect. The glass is a non-toxic material, and it represents a guarantee for the hygiene and a perfect cleaning.



**AL/P500VE  
 AL/P600VE**  
 Piano in vetro colorato sp. 15 con alzatina.  
 Worktop in coloured glass th. 15 with rim.

**NOTE**  
 Su richiesta altri colori. Sabbiatura con finitura antimpronta su piano vetro.  
 Other colours and sandblasting with no-fingerprint finishing on the glass worktop available on request.





**PIANO IN SILESTONE®**

Piano in Silestone® con spessore 30 mm composto da quarzo naturale, un materiale di straordinarie caratteristiche quali durezza e resistenza. Primo e unico piano con protezione batteriostatica capace di garantire un alto livello d'igiene e, grazie ai suoi grandi formati, un ridottissimo numero di giunti.

**SILESTONE® TOP**

Silestone® top thickness 30 mm made of natural quartz, a material with amazing features such as hardness and resistance. First and unique top with bacteriostatic protection able to guarantee a high hygiene level and, thanks to its big sizes, a reduced number of joints.



**AL/P500ST  
AL/P600ST**

Piano in Silestone® sp. 30 con alzatina.

Worktop in Silestone® th. 30 with rim.



Su richiesta altri colori.  
Other colours available on request.



**AL/ALTE**

Alzatina tecnica in alluminio con terminali in plastica. Inserimento e cablaggio di interruttori o prese elettriche e prese dati. Sistemi incorporati serie Berker Integro.

Technical rim in aluminium with plastic extremities. Insert and cabling of electrical sockets and data socket. Berker Integro systems incorporated.



Su richiesta altri accessori.  
Other accessories available on request.

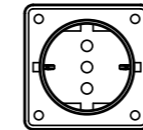

**AL/PRDE**

Presca schuko standard Berker per alzatina.

Standard Berker Schuko socket for technical rim.

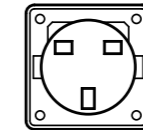

**AL/PRGB**

Presca British standard Berker per alzatina.

Standard British Berker socket for technical rim.

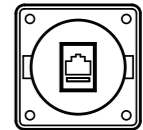

**AL/PRJ**

Presca dati RJ45 cat 5 Berker per alzatina.

Data Berker socket RJ45 cat. 5 for technical rim.

# Funzionalità senza rinunciare allo stile.

I lavelli e i miscelatori devono essere appropriati ai diversi usi, lavarsi le mani, lavare e sciacquare lo strumentario e contemporaneamente aggiungere un tocco di stile allo studio e al laboratorio. Nel nostro assortimento troverai la soluzione perfetta.

# Functionality without renouncing to style.

*Sinks and mixers have to be appropriate to different uses (washing hands, washing and rinse out the instruments) and at the same time they have to add a touch of style to the practice and laboratory. In our assortment you will find the perfect solution.*



**AL/LIL**  
Lavello in acciaio inox 304 con forma a sfera e finitura lucida a specchio, senza foro troppopieno, da incasso sopra piano. (Consigliato l'utilizzo nello studio).

*304 stainless steel spherical sink and gloss finish, without overflow hole, to be built above the top. (Recommended for the practice).*

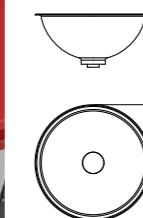

**AL/MIXT**  
Miscelatore lavabo con leva clinica.  
*Clinic lever mixer.*

**AL/MIXEC**  
Miscelatore elettronico lavabo.  
*Electronic mixer.*

Optional: AL/DS



**AL/LCS**  
Lavello in ceramica porcellanata bianca con forma ovale per incasso sopra piano con bordo perimetrale arrotondato e completo di foro miscelatore. Facile da pulire, ecologico, con il suo bianco candido può essere abbinato a tutti i colori dei piani. (Consigliato l'utilizzo nello studio).

*White porcelain - ceramic sink, with oval shape to be built above the top. Rounded rim along the perimeter, with hole for mixer. Easy to clean, eco-friendly, with its pure white it can be combined with any colour of top. (Recommended for the practice).*

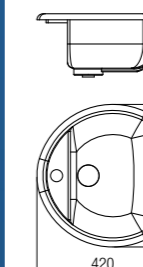

**AL/MIXL**  
Miscelatore lavabo con leva clinica.  
*Long lever mixer tap.*



**AL/LCF**  
Lavello in ceramica porcellanata bianca con forma ovale, integrato a filo piano e invaso perimetrale completo di foro miscelatore. Facile da pulire, ecologico, incasso possibile solo su piani in laminato. (Consigliato l'utilizzo nello studio).

*White porcelain - ceramic sink, with oval shape and at plain level. Drainer recess along the perimeter with hole for mixer. Easy to clean, eco-friendly. Recess possible only in laminate tops. (Recommended for the practice).*

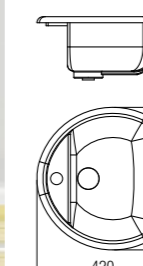

**AL/MIXL**  
Miscelatore lavabo con leva clinica.  
*Long lever mixer tap.*

**AL/MIXEP**  
Miscelatore elettronico lavabo.  
*Electronic mixer.*



**AL/LIS**

Lavello in acciaio inox 304 con finitura spazzolato, forma rettangolare, incasso sopra piano, facile da pulire e altamente igienico e duraturo nel tempo. (Consigliato l'utilizzo nel laboratorio e con piano profondità 600mm).

304 stainless steel sink with brushed finish. Rectangular shape, recessed above the top. Easy to clean and highly hygienic and long-lasting. (Recommended for the laboratory with top 600mm deep).

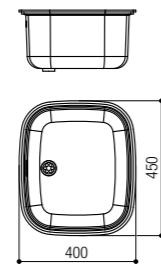

**AL/MIXC**  
Miscelatore collo alto con leva clinica.  
High mixer tap with clinic lever.

**AL/MIXD**  
Miscelatore doccetta estraibile e leva clinica.  
Mixer tap with clinic lever and pull-out shower.



**AL/LIX2V**

Lavello in acciaio inox 304 da incasso con due vasche in finitura prelucido in versione economica. (Consigliato l'utilizzo nel laboratorio).

304 stainless steel sink with 2 basins in glossy finishing in economical version. (Recommended for the laboratory).

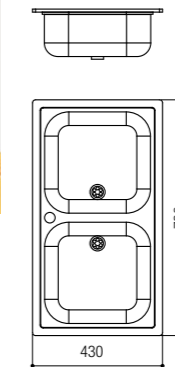

**AL/MIXC**  
Miscelatore collo alto con leva clinica.  
High mixer tap with clinic lever.

**AL/MIXD**  
Miscelatore doccetta estraibile e leva clinica.  
Mixer tap with clinic lever and pull-out shower.

Optional: AL/RUA - AL/GRI



**AL/LIF**

Lavello in acciaio inox 304 con finitura spazzolato, forma rettangolare, incasso integrato al piano, facile da pulire e altamente igienico e duraturo nel tempo. (Consigliato l'utilizzo nel laboratorio).

304 stainless steel sink with brushed finish. Rectangular shape, recess in the top. Easy to clean and highly hygienic and long-lasting. (Recommended for the laboratory).

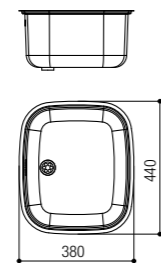

**AL/MIXC**  
Miscelatore collo alto con leva clinica.  
High mixer tap with clinic lever.

**AL/MIXD**  
Miscelatore doccetta estraibile e leva clinica.  
Mixer tap with clinic lever and pull-out shower.



**AL/VQIS**

Lavello in acciaio inox 304 saldato su piano, forma un corpo unico insieme al piano di lavoro sempre in acciaio, non ci sono fessure per infiltrazioni, l'alzatina è integrata. (Consigliato l'utilizzo nella sterilizzazione e nel laboratorio).

304 stainless steel sink welded on the top, it forms a unique body with the stainless steel worktop. There are no cracks for seepages, the rim is included. (Recommended for the sterilization room and the laboratory).

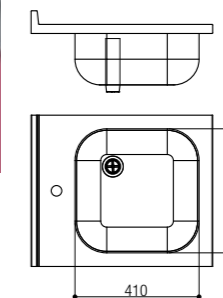

**AL/MIXC**  
Miscelatore collo alto con leva clinica.  
High mixer tap with clinic lever.

**AL/MIXD**  
Miscelatore doccetta estraibile e leva clinica.  
Mixer tap with clinic lever and pull-out shower.

Optional: AL/RUA - AL/GRI1



**AL/LIX+SG**

Lavello in acciaio inox 304 da incasso con una vasca più sgocciolatoio in finitura prelucido in versione economica, la vasca può essere dx o sx. (Consigliato l'utilizzo nel laboratorio).

304 stainless steel sink with sink and drainer in glossy finishing in economical version. The basin can be right or left. (Recommended for the laboratory).

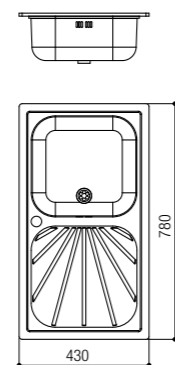

**AL/MIXC**  
Miscelatore collo alto con leva clinica.  
High mixer tap with clinic lever.

**AL/MIXD**  
Miscelatore doccetta estraibile e leva clinica.  
Mixer tap with clinic lever and pull-out shower.

Optional: AL/RUA



**AL/VQIS+SG**

Lavello in acciaio inox 304 saldato su piano, forma un corpo unico insieme al piano di lavoro sempre in acciaio, lateralmente vengono stampate rigature per formare uno sgocciolatoio, completo di alzatina integrata e bordo perimetrale anti trascinamento. (Consigliato l'utilizzo nella sterilizzazione e nel laboratorio).

304 stainless steel sink welded on the top, it forms a unique body with the stainless steel worktop. Rifling is made on the side in order to create a drainer. Completed of integrated rim and anti-overflow rim along the perimeter. (Recommended for the sterilization room and the laboratory).

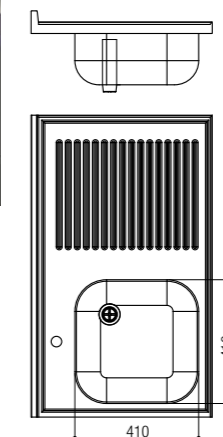

**AL/MIXC**  
Miscelatore collo alto con leva clinica.  
High mixer tap with clinic lever.

**AL/MIXD**  
Miscelatore doccetta estraibile e leva clinica.  
Mixer tap with clinic lever and pull-out shower.

Optional: AL/RUA



**CORIAN®**

Lavello in Corian® Glacier White ricavato tramite termoformatura con forma circolare e morbida, il lavello si presenta privo di giunture e dello stesso colore del piano, vasca senza troppo pieno. (Consigliato l'utilizzo nello studio).

*Glacier White Corian® sink obtained through thermoforming. Circular and soft shape, the sink has no joints and it is of the same colour of the top. Basin without overflow. (Recommended for the practice).*

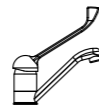
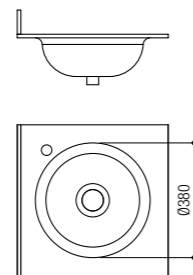

**AL/MIXT**  
Miscelatore lavabo con leva clinica.  
*Clinic lever mixer.*



**AL/MIXEC**  
Miscelatore elettronico lavabo.  
*Electronic mixer.*



**AL/VCO**

Lavello in Corian® bianco dalla forma ovale e morbida, viene integrato al piano per dare vita a un insieme omogeneo, con giunture invisibili dove non si può annidare lo sporco. Possibilità di essere integrato solo su piani con spessore da 30 mm (Consigliato l'utilizzo nello studio).

*Corian® sink with oval and soft shape, integrated to the top to give life to a homogeneous combination, with invisible joints where filth cannot nestle. It can be integrated only on tops which are 30 mm thick. (Recommended for the practice).*

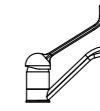
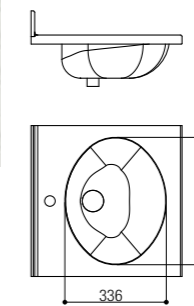

**AL/MIXT**  
Miscelatore lavabo con leva clinica.  
*Clinic lever mixer.*

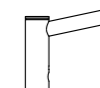

**AL/MIXEC**  
Miscelatore elettronico lavabo.  
*Electronic mixer.*

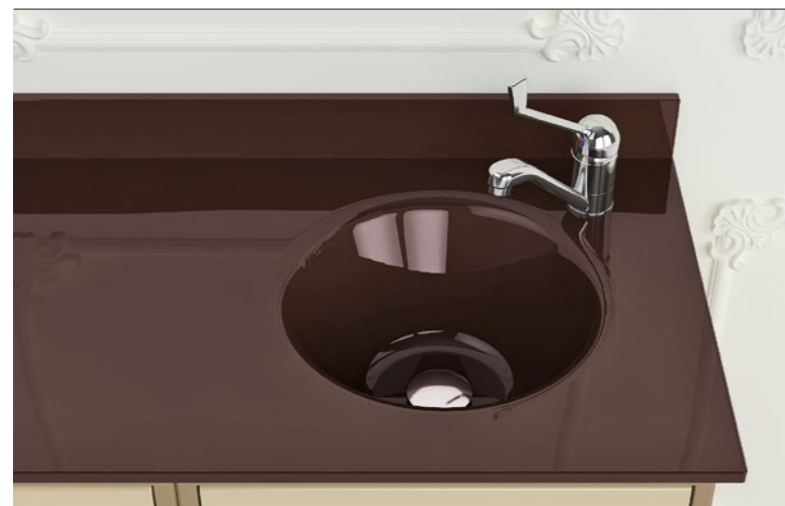

**VETRO**

Lavello in vetro ricavato tramite fusione con forma circolare e morbida, piano e lavello si presentano come un corpo unico verniciato dello stesso colore, con vernici che garantiscono una perfetta tenuta nel tempo. (Consigliato l'utilizzo nello studio).

*Glass sink obtained through melting. Circular and soft shape, top and sink are a unique body painted with the same colour, with paints which guarantee a perfect resistance over time. (Recommended for the practice).*

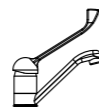
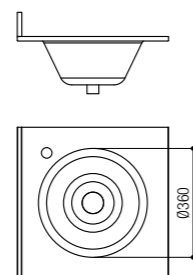

**AL/MIXT**  
Miscelatore lavabo con leva clinica.  
*Clinic lever mixer.*



**AL/MIXEC**  
Miscelatore elettronico lavabo.  
*Electronic mixer.*



Optional: AL/SI2

**AL/VCQ**

Lavello in Corian® bianco dalla forma quadrata con angoli arrotondati, viene integrato al piano per dare vita a un insieme omogeneo con giunture invisibili dove non si può annidare lo sporco. Possibilità di essere integrato solo su piani con spessore da 30 mm (Consigliato l'utilizzo nella sterilizzazione e nel laboratorio).

*White Corian® sink with square shape and rounded corners. Integrated to the top to give life to a homogeneous combination with invisible joints where filth cannot nestle. It can be integrated only on tops which are 30 mm thick. (Recommended for the sterilization room and the laboratory).*

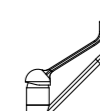
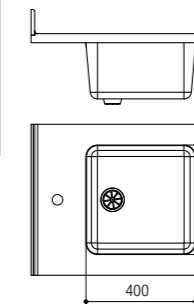

**AL/MIXC**  
Miscelatore collo alto con leva clinica.  
*High mixer tap with clinic lever.*

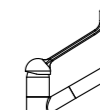

**AL/MIXD**  
Miscelatore doccetta estraibile e leva clinica.  
*Mixer tap with clinic lever and pull-out shower.*



**AL/VQS**

Lavello monoblocco in Silestone® dal design elegante e innovativo, offre una totale integrazione, una eccellente funzionalità e un affascinante stile. Le proprietà di Integrity regalano l'idea di continuità, riducono il numero di fessure e giunti e danno la massima igiene e facilità di pulizia. (Consigliato l'utilizzo nello studio nella sterilizzazione e nel laboratorio).

*Single-piece Silestone® sink. With an elegant and innovative design, it offers a total integration, an excellent functionality and a fascinating style. The features of Integrity give the idea of continuity, reduce the number of cracks and joints and give the best hygiene and ease of cleaning. (Recommended for the practice, the sterilization room and the laboratory).*

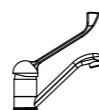
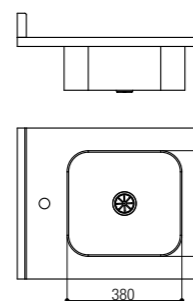

**AL/MIXT**  
Miscelatore lavabo con leva clinica.  
*Clinic lever mixer.*



**AL/MIXEC**  
Miscelatore elettronico lavabo.  
*Electronic mixer.*



**AL/VCQS**

Lavello in Corian® bianco dalla forma quadrata con angoli arrotondati, viene integrato al piano per dare vita a un insieme omogeneo con giunture invisibili dove non si può annidare lo sporco. Sgocciolatoio realizzato tramite fresatura della lastra, lavorazione solo su piani spessore 30 mm (Consigliato l'utilizzo nella sterilizzazione e nel laboratorio).

*White Corian® sink with square shape and rounded corners. Integrated to the top to give life to a homogeneous combination with invisible joints where filth cannot nestle. Drainer obtained through the milling of the sheet. Production only on tops which are 30 mm thick. (Recommended for the sterilization room and the laboratory).*

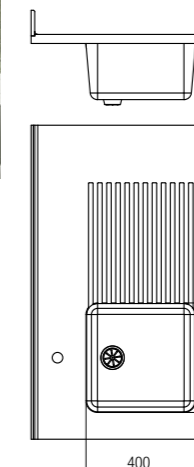

**AL/MIXK**  
Miscelatore alto con canna e doccia flex.  
*High mixer tap with flex shower.*

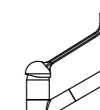

**AL/MIXD**  
Miscelatore doccetta estraibile e leva clinica.  
*Mixer tap with clinic lever and pull-out shower.*



# Raccolta differenziata.

Differenti tipologie di contenitori per una corretta gestione dei rifiuti, ante o cassetti che si possono aprire anche quando hai le mani occupate, cesti in tondino di acciaio cromato ancorati all'interno dell'anta, oppure cassetto per scatola cartone rifiuti speciali, contenitore per aghi e taglienti inserito all'interno dell'anta.

# Waste management.

*Different types of containers for a correct waste management. Doors or drawers that can be opened even when your hands are busy, baskets in chromed steel rod fastened inside the door, or drawer for cardboard-box for special waste, container for needles and cutting edges placed on the inside of the door.*



## Mobile H840 lavello e tipologia aperture / Unit H840 sink and opening type

### AL/ML1AS

Mobile per lavello con apertura a spinta.  
Unit for sink with toggle opening.

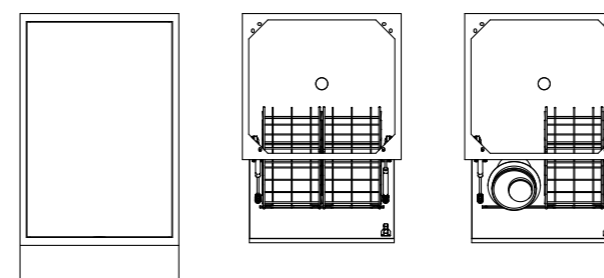

### AL/ML1

Mobile per lavello con apertura dx-sx.  
Unit for sink with Right-Left opening.

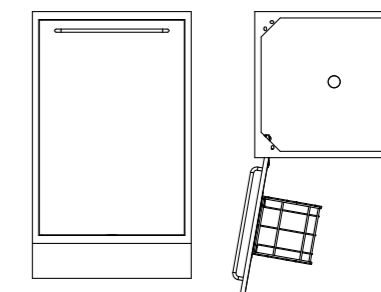

### AL/ML1CA.AS

Mobile per lavello con cassetto estraibile e apertura a spinta.  
Unit for sink with pull-out drawer and toggle opening.

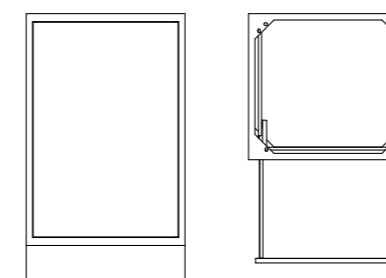

### AL/ML1BO

Mobile per lavello con botola.  
Unit for sink with waste chute.

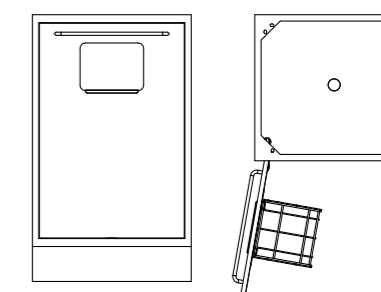

### AL/MAL3AS

Mobile lavello angolare con apertura a spinta.  
Corner unit for sink with toggle opening.

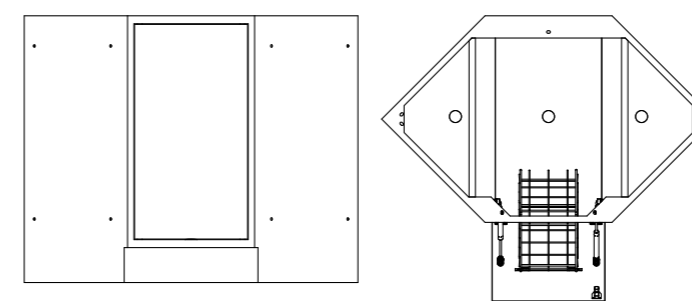

### AL/MAL3

Mobile lavello angolare con apertura dx-sx.  
Corner unit for sink with Right-Left opening.

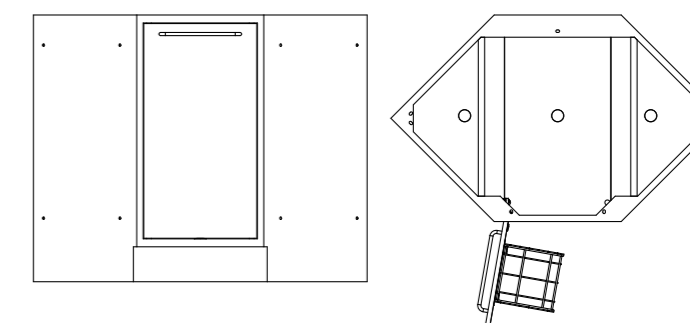

### AL/MAL3BO

Mobile lavello angolare con botola.  
Corner unit for sink with waste chute.

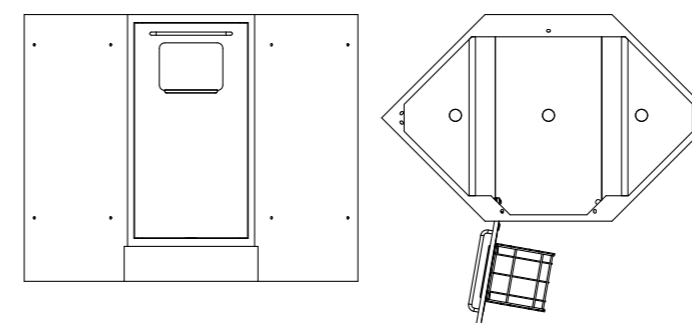

**Mobile H840 lavello e tipologia aperture / Unit H840 sink and opening type**

**AL/MSPL1.AS**

Mobile per lavello con apertura a spinta.  
Unit for sink with toggle opening.

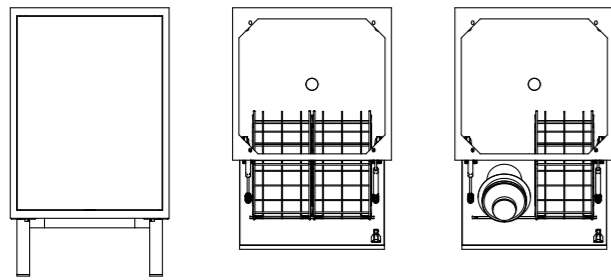

**AL/MSPL1**

Mobile per lavello con apertura dx-sx.  
Unit for sink with Right-Left opening.

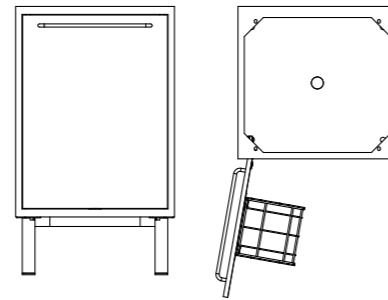

**AL/MSPL1CA.AS**

Mobile per lavello con cassettone estraibile e apertura a spinta.  
Unit for sink with pull-out drawer and toggle opening.

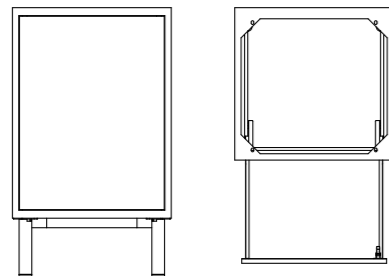

**AL/MASPL3AS**

Mobile lavello angolare con apertura a spinta.  
Corner unit for sink with toggle opening.

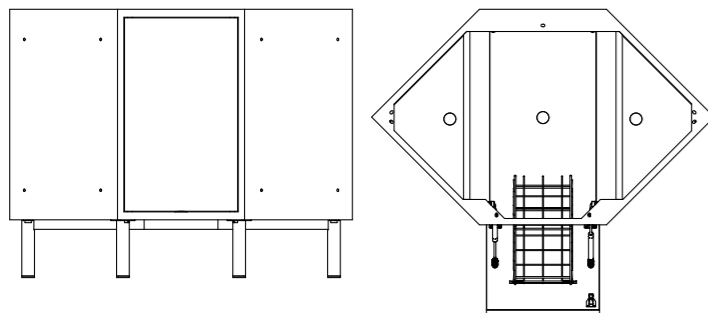

**AL/MASPL3**

Mobile lavello angolare con apertura dx-sx.  
Corner unit for sink with Right-Left opening.

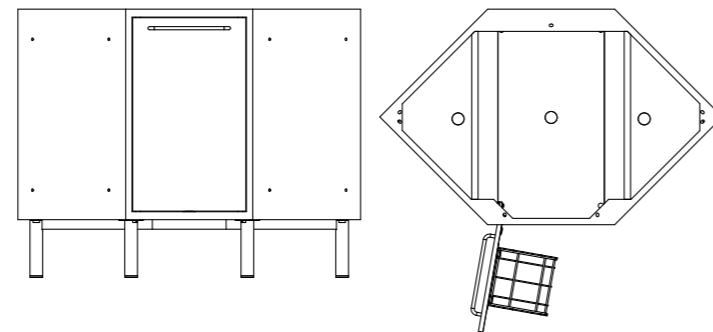

**Mobile H976 lavello e tipologia aperture / Unit H976 sink and opening type**

**AL/MLA1AS**

Mobile per lavello con apertura a spinta.  
Unit for sink with toggle opening.

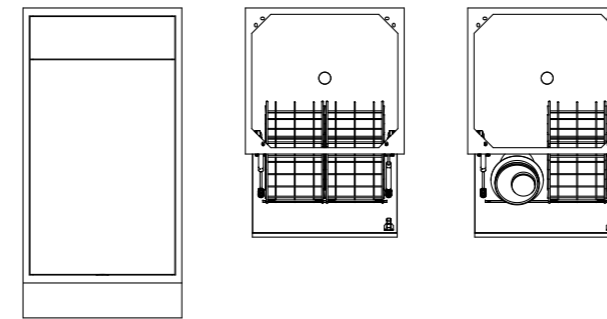

**AL/MLA1**

Mobile per lavello con apertura dx-sx.  
Unit for sink with Right-Left opening.

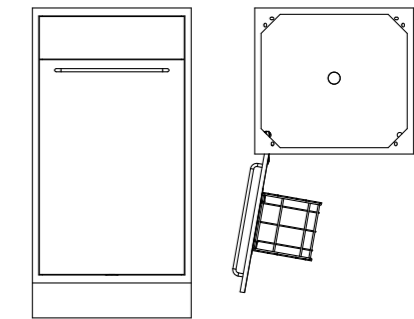

**AL/MLA1CA.AS**

Mobile per lavello con cassettone estraibile e apertura a spinta.  
Unit for sink with pull-out drawer and toggle opening.

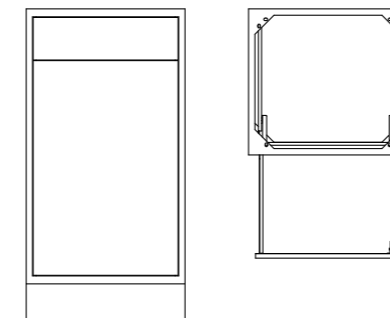

**AL/MLA1.BO**

Mobile per lavello con botola.  
Unit for sink with waste chute.

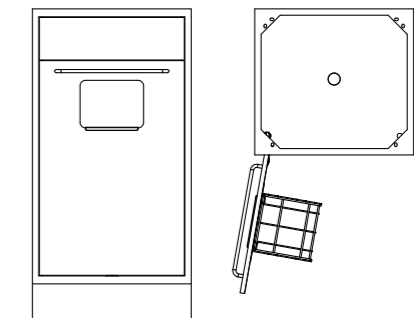

**Mobile H840 lavello doppio e tipologia aperture / Double unit H840 for sink and opening type**

**AL/ML2**

Mobile per lavello doppio con apertura dx-sx.  
Double unit for sink with Right-Left opening.

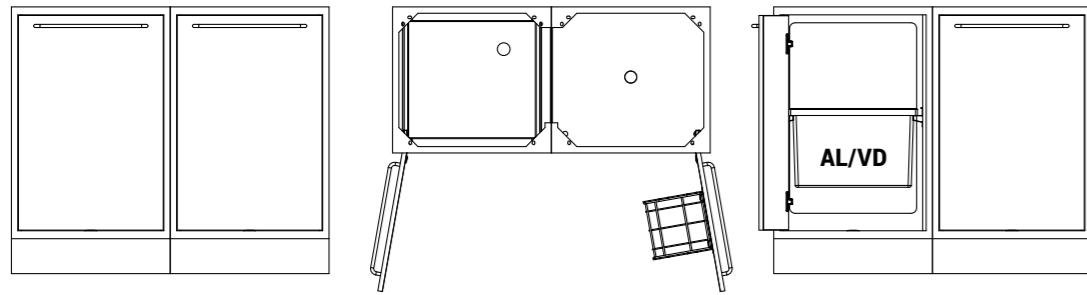

**AL/MSPL2**

Mobile per lavello doppio con apertura dx-sx.  
Double unit for sink with Right-Left opening.

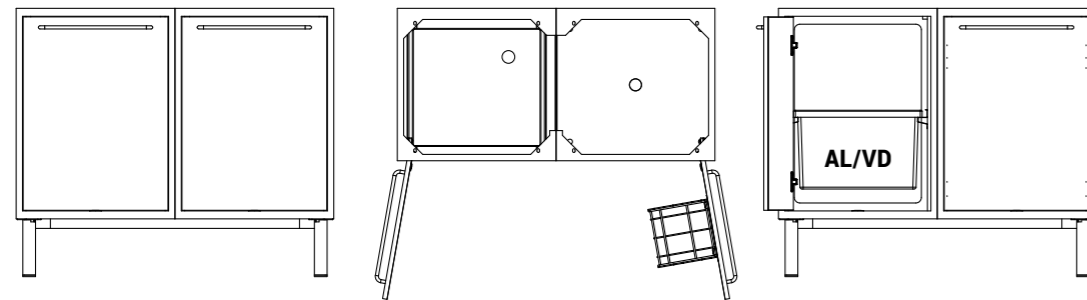

**Mobile H976 lavello doppio e tipologia aperture / Double unit H976 for sink and opening type**

**AL/MLA2**

Mobile per lavello doppio con apertura dx-sx.  
Double unit for sink with Right-Left opening.

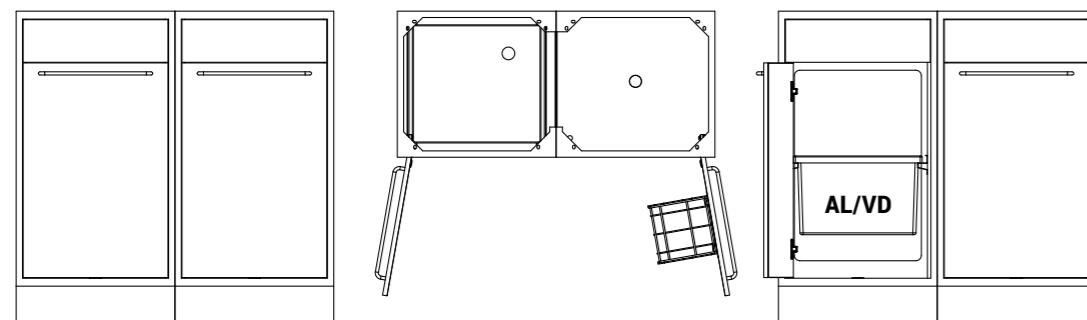

**Mobile H840 portarifiuti e tipologia aperture / Unit H840 for waste and opening type**

**AL/M1CA**

Mobile cassettone estraibile.  
Unit with pull-out drawer.

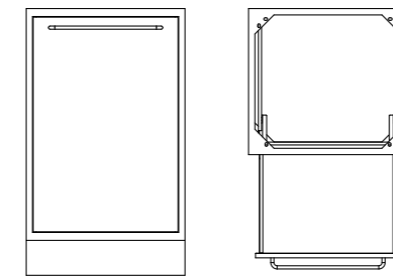

**AL/M1.BOT**

Mobile per scatola portarifiuti 50 l con botola.  
Unit for waste box 50 l with waste chute.

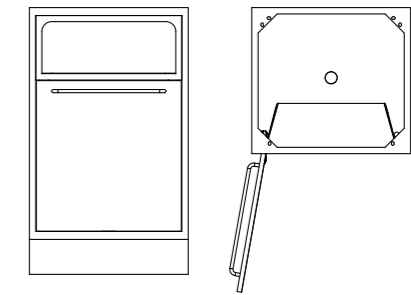

**AL/MSP1CA**

Mobile cassettone estraibile.  
Unit with pull-out drawer.

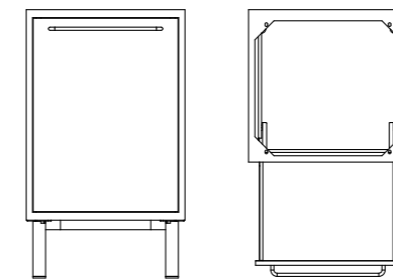

**AL/MSP1.BOT**

Mobile per scatola portarifiuti 40 l con botola.  
Unit for waste box 40 l with waste chute.

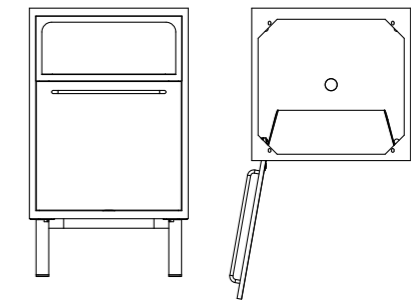

# Spazi organizzati.

Cassetti in metallo verniciato di varie dimensioni a estrazione quasi totale con guida a scorrimento su rotelle e chiusura self-closing, organizzati con inserti bianchi in Pst atossico adatti alle varie dimensioni con diversa capienza e suddivisione interna per trovare posto ad ogni cosa.

# Organized spaces.

*Drawers in painted metal of various dimensions, almost entirely extractable, with self-closing ball-bearing slides, organized with white inserts in non-toxic Pst suitable for various dimensions with different capacity and internal partitions to find a place for everything.*



## Tipologia e dimensioni cassetti / Typology and dimension of drawers

**A** Cassetto **A** per mobile da 500 mm.  
Drawer **A** for unit 500 mm.

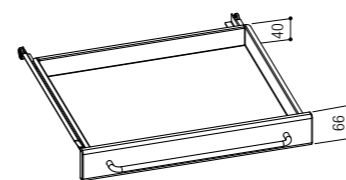

**B** Cassetto **B** per mobile da 500 mm.  
Drawer **B** for unit 500 mm.

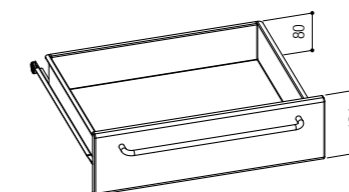

**C** Cassetto **C** per mobile da 500 mm.  
Drawer **C** for unit 500 mm.

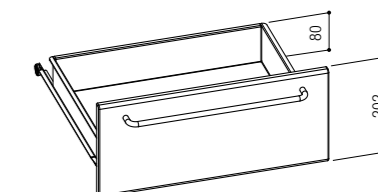

**D** Cassetto **D** per mobile da 500 mm.  
Drawer **D** for unit 500 mm.

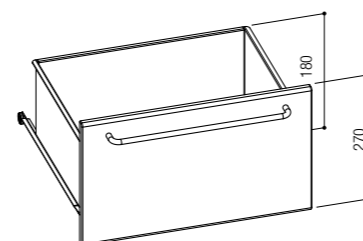

**E** Cassetto **E** per mobile da 500 mm.  
Drawer **E** for unit 500 mm.

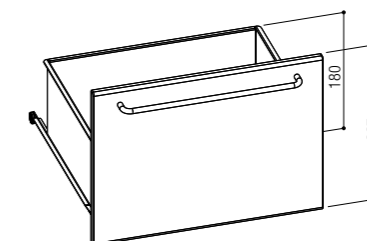

**H** Cassetto **H** per mobile da 500 mm.  
Drawer **H** for unit 500 mm.

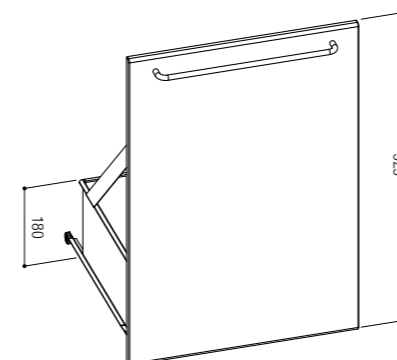

**I** Cassetto **I** per per cassetiera da 640 mm.  
Drawer **I** for unit 640 mm.

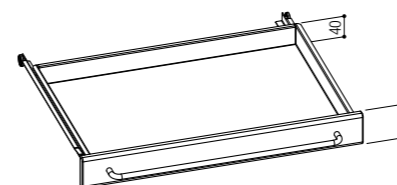

**L** Cassetto **L** per per cassetiera da 640 mm.  
Drawer **L** for unit 640 mm.

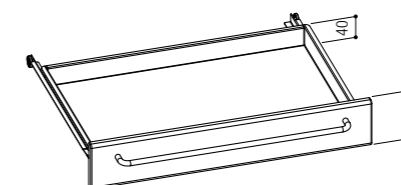

**M** Cassetto **M** per mobile da 400 mm.  
Drawer **M** for unit 400 mm.

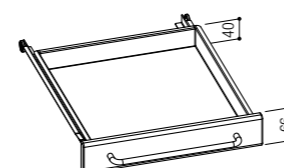

**N** Cassetto **N** per mobile da 400 mm.  
Drawer **N** for unit 400 mm.

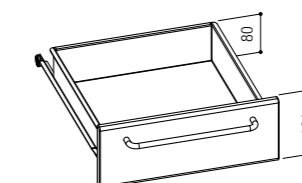

**O** Cassetto **O** per mobile da 600 mm.  
Drawer **O** for unit 600 mm.

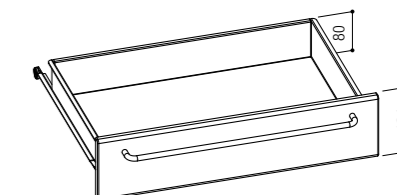

Forme e dimensioni bacinelle / Shape and dimension of trays

Cassetto **A**  
Drawer

Bacinella **A** liscia  
Tray **A** smooth

Bacinella **A** 8 scomparti  
Tray **A** 8 compartments

Bacinella **A** 12 scomparti  
Tray **A** 12 compartments

Bacinella **A** cremagliera  
Tray **A** track

Cassetto **I-L**  
Drawer

Bacinella **I-L** liscia  
Tray **I-L** smooth

Bacinella **I-L** 6 scomparti  
Tray **I-L** 6 compartments

Bacinella **I-L** 17 scomparti  
Tray **I-L** 17 compartments

Cassetto **B-C**  
Drawer

Bacinella **B-C** liscia  
Tray **B-C** smooth

Bacinella **B-C** 2 scomparti  
Tray **B-C** 2 compartments

Bacinella **B-C** 4 scomparti  
Tray **B-C** 4 compartments

Bacinella **B-C** 5 scomparti  
Tray **B-C** 5 compartments

Cassetto **M**  
Drawer

Bacinella **M** liscia  
Tray **M** smooth

Bacinella **B-C** farmacia  
Tray **B-C** drugstore

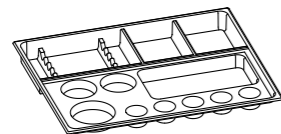

Cassetto **N**  
Drawer

Bacinella **N** liscia  
Tray **N** smooth

Cassetto **D-E-H**  
Drawer

Bacinella **D-E-H** liscia  
Tray **D-E-H** smooth

Cassetto **O**  
Drawer

Bacinella **O** liscia  
Tray **O** smooth

## Lampade coordinate.

Una buona illuminazione è fondamentale in ogni zona lavoro, proponiamo diverse soluzioni, lampade da tavolo a snodo, lampade lineari sostenute da pali, o in variante ovale con estetica coordinata al bordo del piano lavoro e sistemi di illuminazione integrati nell'arredo.

## Matching lamps.

*A good illumination is fundamental in every working zone. We offer different solutions: balanced-arm lamp for bench, linear lamps supported by poles or in the oval version with aesthetics matched to the worktop rim and illumination systems integrated in the furniture.*



### AL/LA

Lampada con neon 3xT5 da 14W.  
Lampada da laboratorio con corpo rettangolare e diffusore cromato con tre tubi lineari fluorescenti T5 da 14W con braccio snodabile e bilanciato, il fissaggio della base lampada è con viti.

*Lamp with neon 3xT5 14 W.  
Laboratory lamp with rectangular body and chromed diffuser with 3 fluorescent and linear tubes T5 of 14W with balanced arm. The fastening of the base of the lamp is made with screws.*

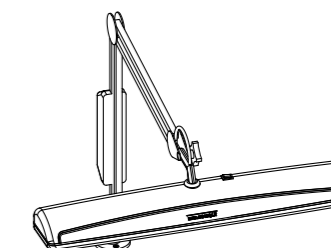

### AL/LE

Lampada con lente 2x PL da 9W.  
Lampada da laboratorio con lente di ingrandimento a 3 diottrie con due bulbi fluorescenti PL da 9W con braccio snodabile e bilanciato, il fissaggio della base lampada è con viti.

*Lamp with lens 2x PL 9W.  
Laboratory lamp with magnifying lens 3 diopters with 2 fluorescent bulbs PL 9W with balanced arm. The fastening of the base of the lamp is made with screws.*

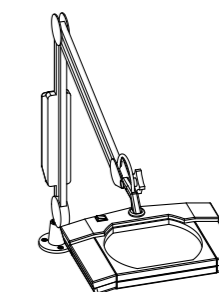

### AL/LA1

Lampada sotto pensile da 13W.  
Lampada sotto pensile con presa 10A ed interruttore, fornita con cavo e tubo fluorescente T5 da 13W, completa di diffusore in policarbonato rigato.

*Lamp for wall unit 13W.  
Lamp for wall unit with socket 10A and switch. Supplied with cable and fluorescent tube T5 13W, equipped with diffuser in lined polycarbonate.*

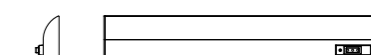



**AL/LO18**

Lampada ovale in metallo verniciato con diffusore in policarbonato acidato, completo di due tubi fluorescenti lineari T8 da 18W e alimentatore elettronico, genera luce sia diretta che indiretta tramite i due diffusori nella parte superiore della lampada.

*Oval lamp in painted steel with diffuser in track-etched polycarbonate, equipped with 2 fluorescent linear tubes T8 18W and electronic charger, creates both direct and indirect light through the 2 diffusers in the upper part of the lamp.*

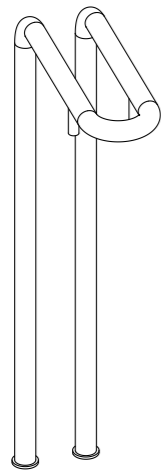
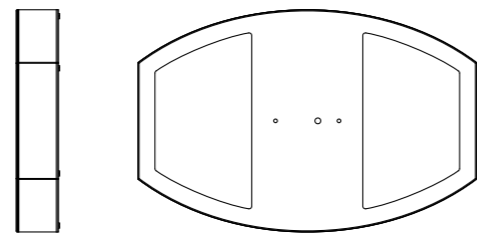

**AL/SMLD**

Palo per lampada ovale, in metallo completo di ghiera per fissaggio al piano, internamente cablato con cavo per alimentare la lampada, anche con staffa supporto mensola DX, SX o centrale.

*Pole in metal for oval lamp, equipped with ferrule for top fastening; internally wired with a cable to provide the lamp with energy, available also with right, left or central support panel for shelves.*

Bordo adesivo in metacrilato per lampada ovale, in versione classica di colore argento oppure in variante pop nei colori qui sotto rappresentati abbinabili ai bordi ABS del piano lavoro.

*Adhesive rim in methacrylate for oval lamp, in the silver classic version, or in pop variation in the colours that are represented below. These colours are matchable to the ABS rims of the worktop.*



Bordo/Rim Argento



Bordo/Rim Pop Grigio



Bordo/Rim Pop Beige



Bordo/Rim Pop Azzurro



Bordo/Rim Pop Giallo



Bordo/Rim Pop Verde



Bordo/Rim Pop Rosso



**AL/LM18**

Lampada in metallo verniciato con diffusore in policarbonato acidato, completo di due tubi fluorescenti lineari T8 da 18W e alimentatore elettronico, con interruttore di accensione posto lateralmente nel fianco, genera solo luce diretta.

*Lamp in painted steel with diffuser in track-etched polycarbonate, equipped with 2 fluorescent linear tubes T8 18W and electronic charger, with switch placed laterally on the side. It creates direct light only.*

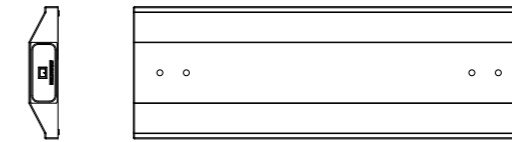

**AL/LM58**

Lampada in metallo verniciato con diffusore in policarbonato acidato, completo di due tubi fluorescenti lineari T8 da 58W e alimentatore elettronico, con interruttore di accensione posto lateralmente nel fianco, genera solo luce diretta.

*Lamp in painted steel with diffuser in track-etched polycarbonate, equipped with 2 fluorescent linear tubes T8 58W and electronic charger, with switch placed laterally on the side. It creates direct light only.*

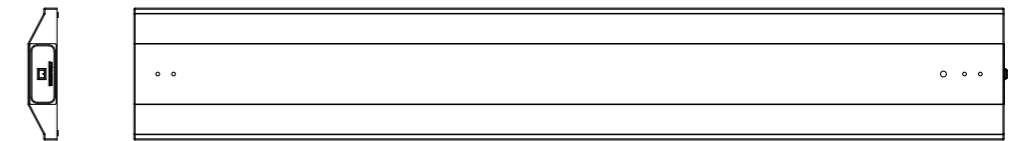

Palo per lampada lineare disponibile in due altezze, in metallo completo di ghiera per fissaggio al piano, internamente cablato con cavo per alimentare la lampada, anche con staffa supporto mensola DX, SX o Centrale.

*Pole in metal for linear lamp, available in two heights, equipped with ferrule for top fastening; internally wired with a cable to provide the lamp with energy, also with right or left or central support panel for shelf.*

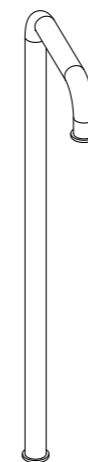

**AL/SMLC**

Montante basso per lampada, anche con staffa supporto mensola DX o SX o centrale.

*Low support for lamp, available also with right, left or central support for shelves.*



**AL/SMLA**

Montante alto per lampada, anche con staffa supporto mensola DX o SX o centrale.

*High support for lamp, available also with right, left or central support for shelves.*

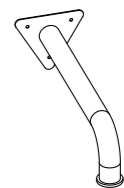

**AL/SLP**

Supporto lampada da parete.

*Support for wall lamp.*



**MENSOLE DAL DESIGN MODERNO**

Una soluzione di mensole ancorate alla struttura posteriore, la finitura in rovere abbinata a tinte neutre crea un'atmosfera calda ed accogliente. Nella lavagna magnetica nera viene stampato il calendario o incassato l'orologio.

**SHELVES OF MODERN DESIGN**

A solution with shelves fastened to the rear structure, the oak finishing is combined to neutral colours which creates a warm and welcoming atmosphere. The calendar is printed on the magnetic blackboard, or a clock can be recessed in it.

**CALENDARIO  
CALENDAR**

				1	2	3
4	5	6	7	8	9	10
11	12	13	14	15	16	17
18	19	20	21	22	23	24
25	26	27	28	29	30	31

**OROLOGIO  
CLOCK**

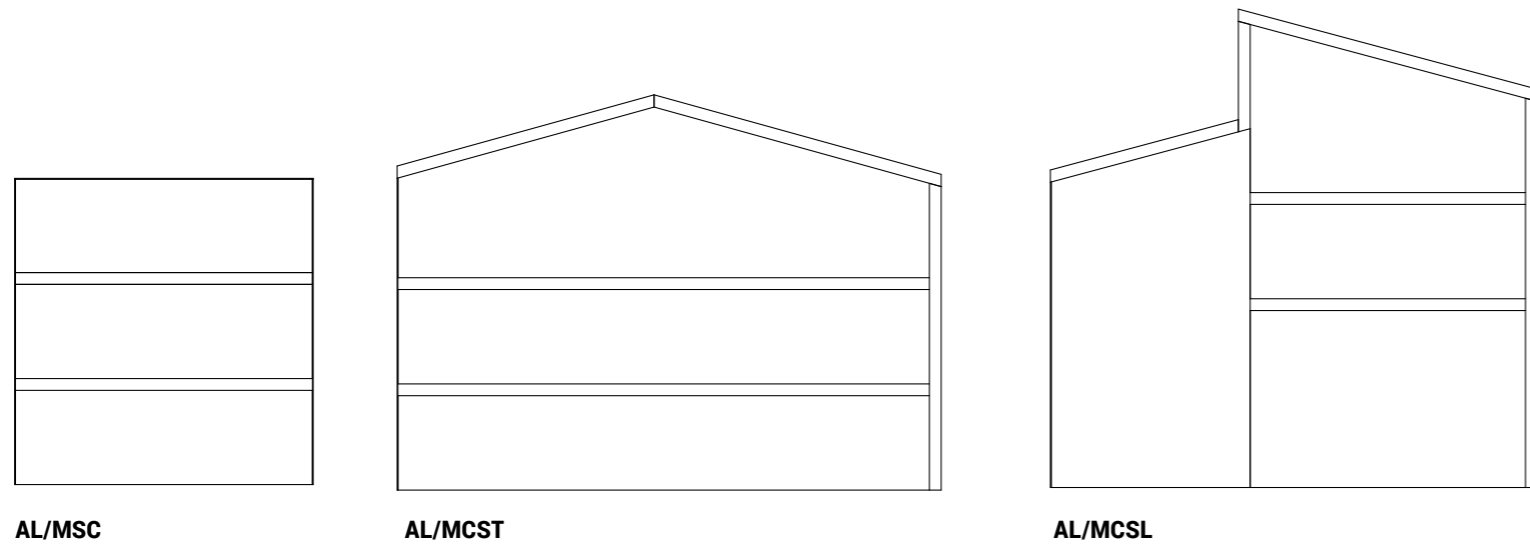
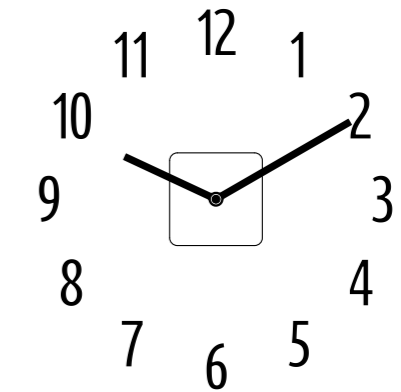

AL/MSK

AL/MCST

AL/MCSL



Rovere Iceland



Rovere Maul



Rovere Valley

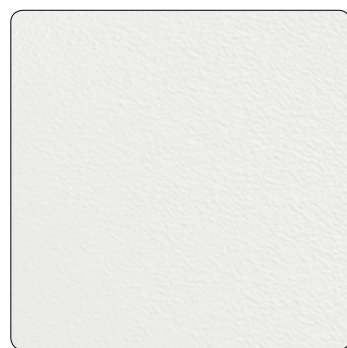

Bianco Artico

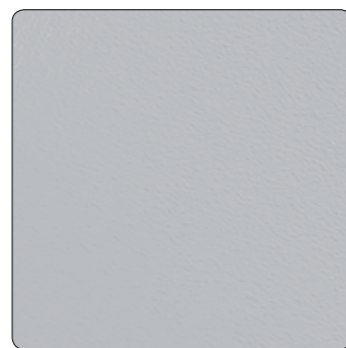

Grigio Perla

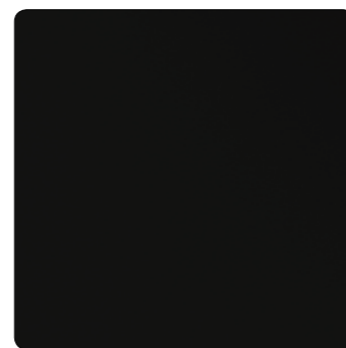

Lavagna Nera



**PANNELLI DI CHIUSURA LUMINOSI**

Una soluzione estetica di grande effetto creata con pannelli luminosi, la scala cromatica della luce LED è regolata con controllo RGB, nella parte interna forata del pannello in metallo è inserita una lastra di metacrilato satinato che fa da diffusore.

**ILLUMINATED CLOSING PANELS**

An aesthetic solution of great impact created by illuminated panels, the colour scale of LED light and regulated with RGB control. In the internal perforated part of the metallic panel a sheet of satin methacrylate, which works as diffuser, is inserted.



LED con controllo RGB.  
LED with RGB control.

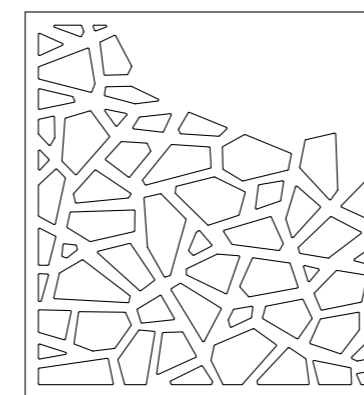

**AL/V61L**

Veletta diritta con foratura e luce LED.

Straight back panel with holes and LED light.

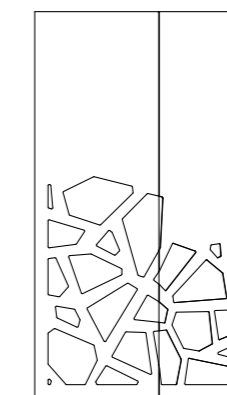

**AL/V62L**

Veletta piegata con foratura e luce LED.

Bended back panel with holes and LED light.





**ZEPPE**  
Supporto lavoro in legno massello di faggio o rovere e supporto per innesto aspirazione in acciaio inox, cuffia di protezione in plexiglas trasparente, supporto anche con poggia bracci.

**BASE**  
Support for work in solid beech or oak and support for suction in stainless steel. Transparent Plexiglas protection screen, with support arm rests.



Sistema automatico di rientro della siringa aria, con tubo diametro 6 mm in poliuretano extraflex nero.

Self-returning air nozzle, with spiral tube diameter 6 mm in black extraflex polyurethane.

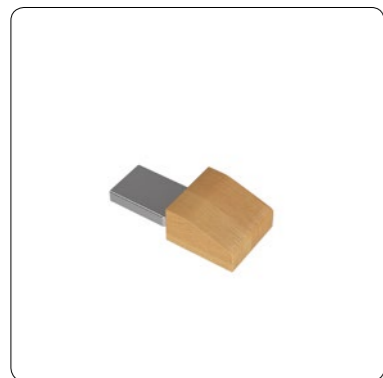
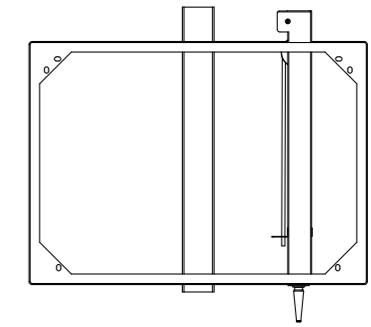

**AL/ZC**  
Zeppa faggio chiusa.  
Wooden closed base.



**AL/ZA**  
Zeppa faggio aperta.  
Wooden open base.



**AL/ZCP**  
Zeppa con cuffia piccola.  
Base with small protection screen.



**AL/ZCG**  
Zeppa con cuffia grande.  
Base with big protection screen.



**AL/ZB**  
Zeppa con braccioli.  
Base with arm rests.



**AL/ZCB**  
Zeppa con cuffia e braccioli.  
Base with protection screen and arm rests.



**AL/PB**  
Supporto e siringa aria con tubo spiralato diametro 6 mm in poliuretano extraflex nero o in diverse varianti colore.

Support and air nozzle with spiral tube diameter 6 mm in black extraflex polyurethane, or in different colours.

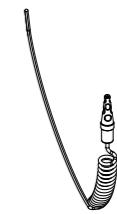

Faggio Naturale



Rovere Iceland



Rovere Maul



Rovere Valley



Giallo  
Yellow



Rosso  
Red



Blu  
Blue



Grigio  
Grey



Nero  
Black



**AL/SDPC**

Realizzata in poliuretano in varie colorazioni, lo schienale è leggermente flessibile, la seduta risulta comoda ed ergonomica, versione girevole con base in acciaio cromato e ruote in gomma morbida con elevatore a gas.

Made of polyurethane and available in different colours, the seatback is slightly flexible, the seat is comfortable and ergonomic, swivel version with chromed steel base and soft rubber wheels with lifting gas.

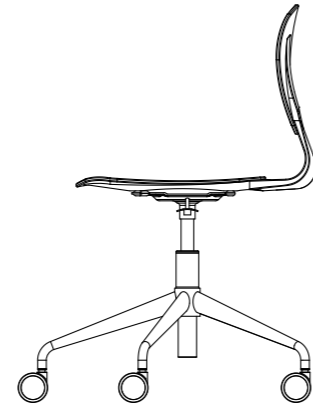

**Colori sedute sedia**  
**Seat colours**



RAL 7015

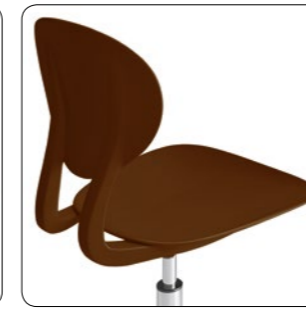

RAL 8014



RAL 2002



RAL 2003



RAL 1023



RAL 7044



RAL 5000



RAL 5002



RAL 4005



RAL 6018



Possibili differenze di tonalità ai RAL indicati.  
Possible differences in shade compared to the indicated RAL colours.



**AL/SAPC**

Realizzata in poliuretano in varie colorazioni, lo schienale è leggermente flessibile, la seduta risulta comoda ed ergonomica, versione fissa con base in acciaio cromato e piedini di livellamento.

Made of polyurethane and available in different colours, the seatback is slightly flexible, the seat is comfortable and ergonomic, fixed version with chromed steel base and levelling feet.

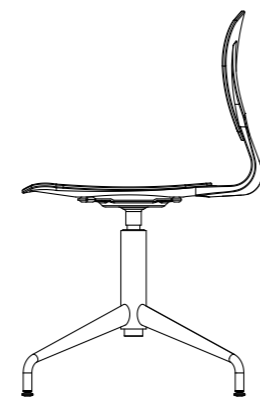

**AL/CSP**

Cuscino imbottito e rivestito in ecopelle di colore grigio.

Upholstered pillow covered of grey synthetic leather.



**AL/BSP**

Braccioli sedia in poliuretano colorato e fissati al telaio cromato.

Coloured polyurethane arm rests fixed on the chromed structure.

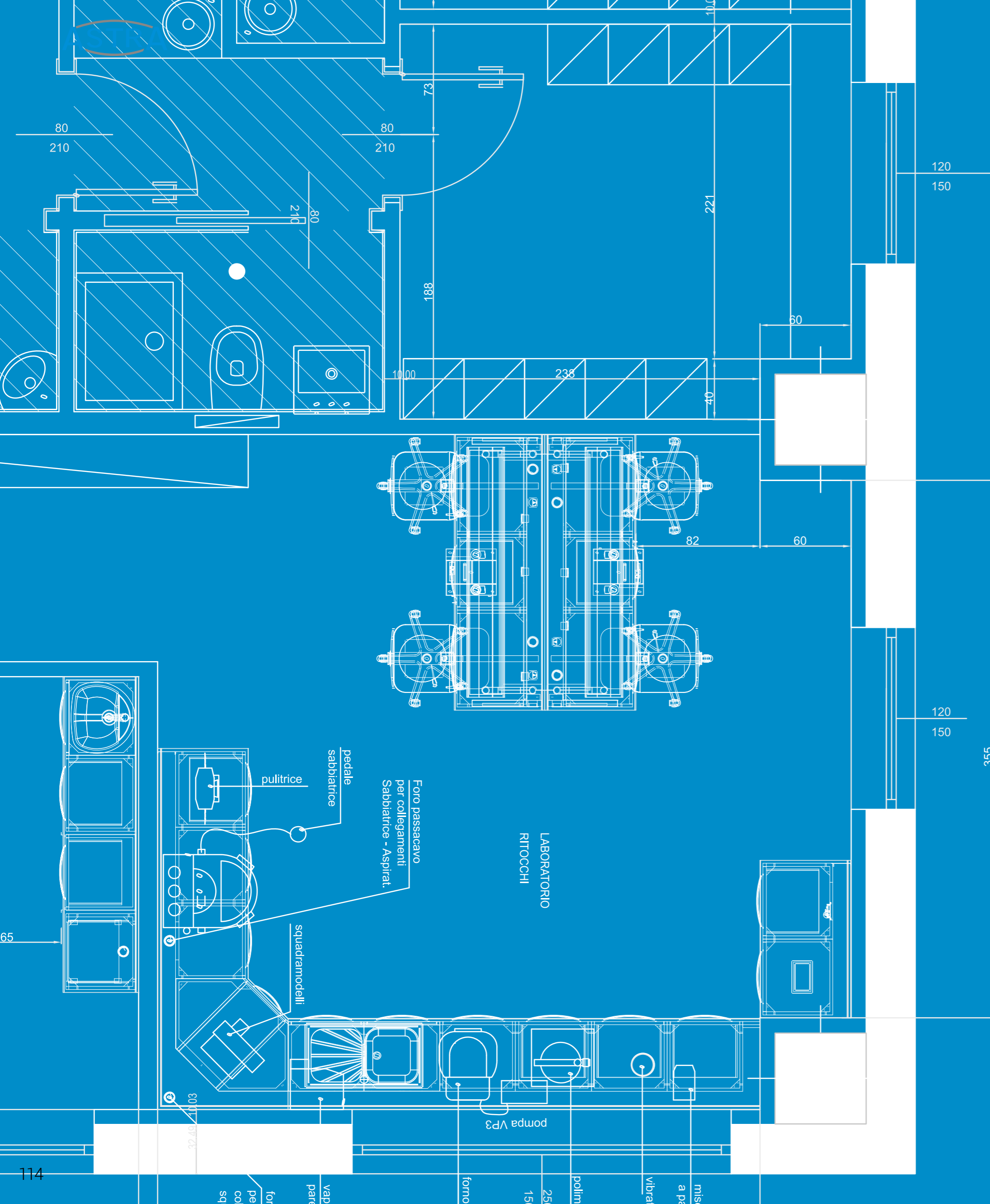

## Adatta i tuoi spazi.

La linea Alius ti permette di creare le soluzioni d'arredo con una rivoluzionaria gamma di elementi che puoi comporre e scomporre come vuoi fino a trovare la soluzione adatta alle esigenze tecniche e agli spazi disponibili.

## Adapt your space.

*Alius line allows you to create furniture solutions with a revolutionary range of elements that you can compose and decompose as you like until you find the right solution to the technical needs and the available space.*

## Guida al progetto.

Gli schemi dei modelli ti portano a conoscenza delle dimensioni dei singoli moduli per le connessioni dell'impiantistica tecnica. Con queste informazioni gli impianti tecnici si potranno predisporre in modo funzionale già a livello progettuale.

## Guide to the design.

*The diagrams of the models inform you about the dimensions of the individual units for the connections of the technical plant. With these information the technical plants can be arranged in a functional way during the project phase.*

## Simulazione integrata.

Configurazione con esempi di composizioni, posizionamento impiantistica di base che può variare in base alle apparecchiature da installare o alle proprie esigenze tecnico-funzionali.

## Integrated simulation.

*Configuration with examples of compositions, positioning of basic plant which can vary according to the equipment to be installed and to the technical-functional needs.*

**MOBILI LINEA CLASSICA**

Una gamma di elementi dalla linea classica con zoccolo componibili adattabili a tutte le tue esigenze per lo studio, la sterilizzazione e il laboratorio.

**CLASSIC LINE UNITS**

A range of elements of classic line with baseboard, modular and adaptable to your needs for the practice, sterilization and laboratory.

**Mobili**

Altezza 976/840/773/704/570 mm  
Profondità 460 mm  
Zoccolo da 110 mm

**Servomobili**

Altezza 778/575 mm  
Profondità 460 mm  
Zoccolo da 110 mm

**Vetrine pensili**

Altezza 730/500 mm  
Profondità 320 mm

**Mensole**

Altezza 500 mm  
Profondità 320 mm

**Units**

Height 976/840/773/704/570 mm  
Depth 460 mm  
Baseboard 110 mm

**Mobile units**

Height 778/575 mm  
Depth 460 mm  
Baseboard 110 mm

**Hanging units**

Height 730/500 mm  
Depth 320 mm

**Shelves**

Height 500 mm  
Depth 320 mm

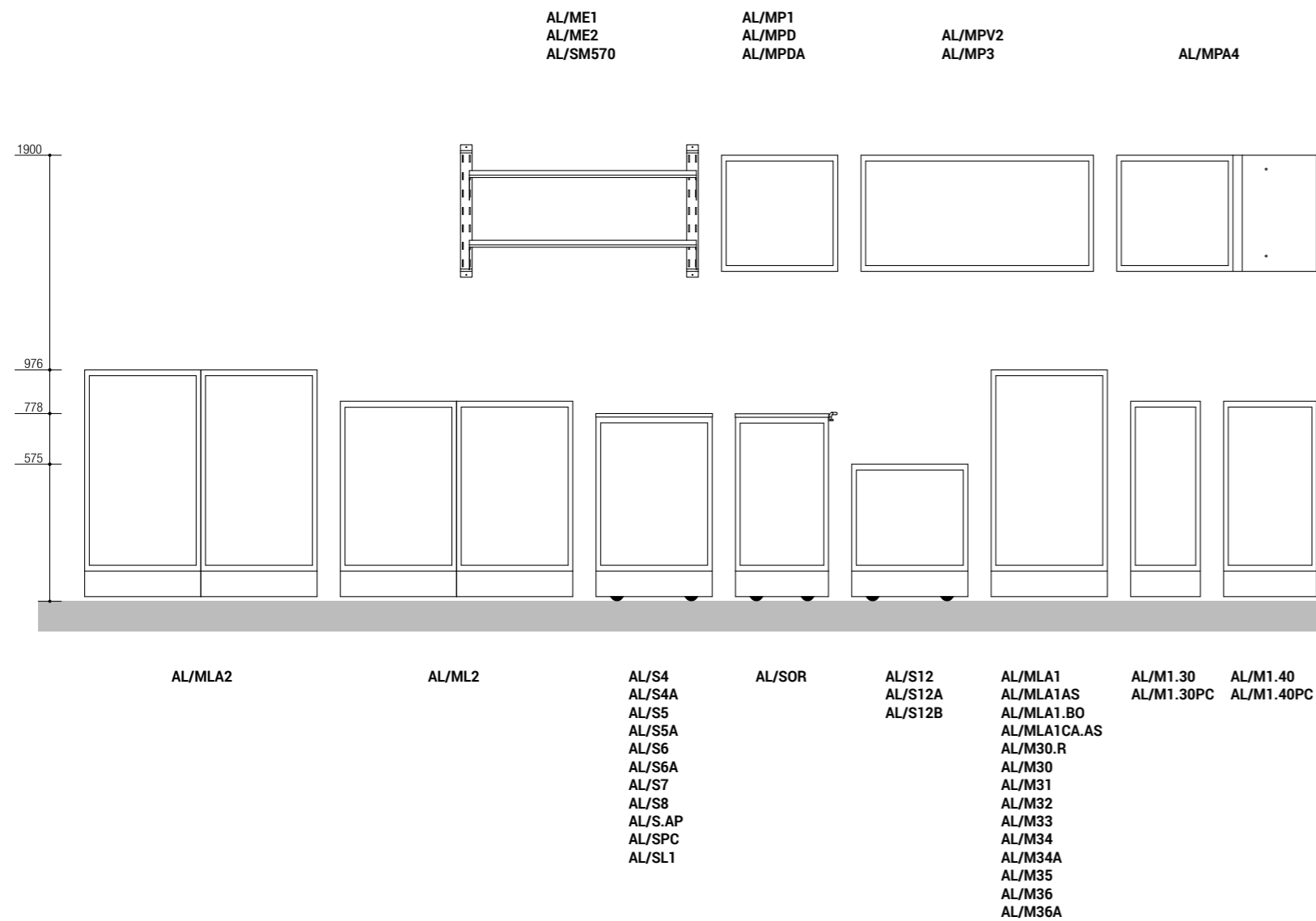

**MOBILI LINEA MODERNA SOSPESA - PENSILE**

Una gamma di elementi dalla linea più moderna ma capiente con sospensioni a telaio, oppure pensili fissati a muro portante adatti a tutte le tue esigenze.

**MODERN SUSPENDED-HANGING UNITS**

A range of elements of the more modern line but spacious with structure suspensions, or hanging units fixed on the bearing wall to meet all your needs.

**Mobili**

Altezza 663 mm  
Profondità 480 mm

**Units**

Height 663 mm  
Depth 480 mm

**Basamenti**

Altezza 177 mm

**Bases**

Height 177 mm

**Servomobili**

Altezza 778 mm  
Profondità 460 mm

**Mobile units**

Height 778 mm  
Depth 460 mm

**Vetrine**

Altezza 500 mm  
Profondità 320 mm

**Hanging units**

Height 500 mm  
Depth 320 mm

**MOBILI LINEA MODERNA MINIMALISTA PENSILI**

Una gamma di elementi dalla linea più minimalista, pensili da fissare a muro portante. Soluzione che facilita la pulizia e l'igiene.

**MODERN MINIMALIST HANGING UNITS**

A range of elements with a more minimalist line, hanging units to be fixed on the bearing wall. This solution facilitates the cleaning and hygiene.

**Mobili**

Altezza 528 mm  
Profondità 480 mm

**Units**

Height 528 mm  
Depth 480 mm

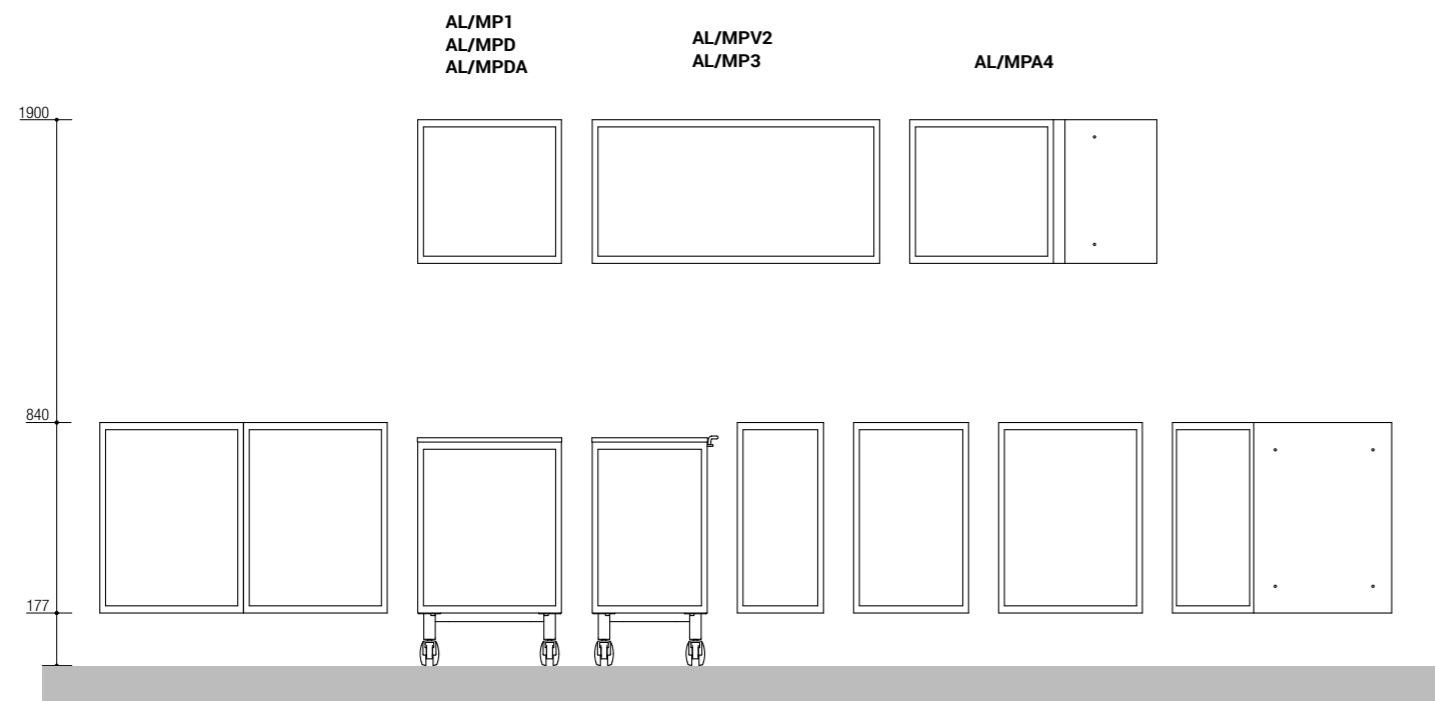

AL/MSPL2

AL/SS4  
AL/SS4A  
AL/SS5  
AL/SS5A  
AL/SS6  
AL/SS6A  
AL/SS7  
AL/SS8  
AL/SSAP  
AL/SS.PC  
AL/SSL1

AL/SS.OR

AL/MSP1.30  
AL/MSP1.30PC

AL/MSP1.40  
AL/MSP1.40PC

AL/MSPL1  
AL/MSPL1.AS  
AL/MSPL1CA.AS  
AL/MSP1CA  
AL/MSP1.BOT  
AL/MSP1  
AL/MSPPC  
AL/MSP2  
AL/MSP3  
AL/MSP4  
AL/MSP4A  
AL/MSP4B  
AL/MSP5  
AL/MSP5A  
AL/MSP5B  
AL/MSP6  
AL/MSP6A  
AL/MSP6B  
AL/MSP7  
AL/MSP7A  
AL/MSP8  
AL/MSP9  
AL/MSP21  
AL/MSP21A  
AL/MSP22  
AL/MSP22A  
AL/MSP23  
AL/MSP23A  
AL/MSP20  
AL/MSP20A

AL/MASPL3  
AL/MASPL3AS  
AL/MASP1

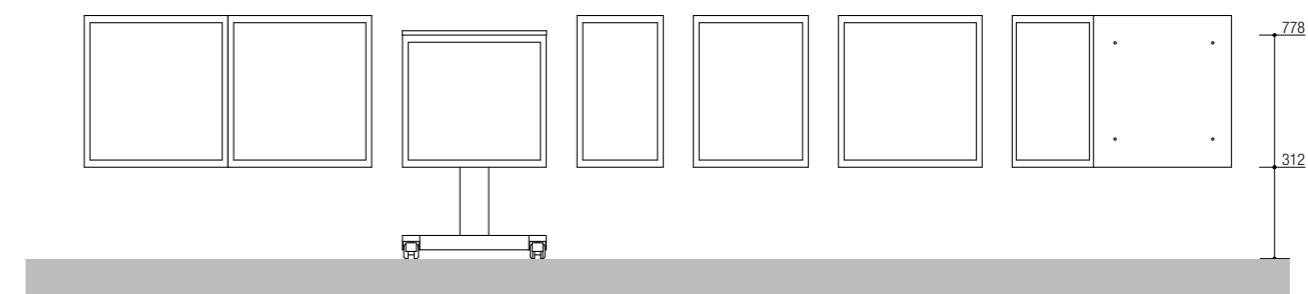

AL/MPBL2

AL/SR3  
AL/SR4  
AL/SR5  
AL/SR6

AL/MPB1.30  
AL/MPB1.30PC

AL/MPB1.40  
AL/MPB1.40PC

AL/MPBL  
AL/MPB1  
AL/MPB2  
AL/MPB2A  
AL/MPB2B  
AL/MPB3  
AL/MPB3A  
AL/MPB3B  
AL/MPB4  
AL/MPB4A  
AL/MPB5  
AL/MPB5A  
AL/MPB6  
AL/MPB7  
AL/MPBE

AL/MPBAL  
AL/MPBAN

**MOBILI TAVOLI LABORATORIO**

Una gamma di elementi, dalla linea più classica a quella sospesa più minimalista, adattabili a tutte le esigenze per il tuo laboratorio personalizzato.

**LABORATORY UNITS**

A range of elements from the classic to the suspended and minimalist line, to meet all the needs for your customized laboratory.

**Mobili sospesi**

Altezza 460/324 mm  
Profondità 460 mm

**Suspended units**

Height 460/324 mm  
Depth 460 mm

**Cassettiere / Portastrumenti**

Altezza 178/242 mm  
Profondità 460 mm

**Drawer units / Instruments elements**

Height 178/242 mm  
Depth 460 mm

**Mobili**

Altezza 840 mm  
Profondità 460 mm  
Zoccolo 110 mm

**Units**

Height 840 mm  
Depth 460 mm  
Baseboard 110 mm

**Vetrine**

Altezza 500 mm  
Profondità 320 mm

**Hanging units**

Height 500 mm  
Depth 320 mm

**Pali lampada**

Altezza 1005/1141 mm

**Support for lamp**

Height 1005/1141 mm

**Pali mensola**

Altezza 270/540 mm

**Support for shelves**

Height 270/540 mm

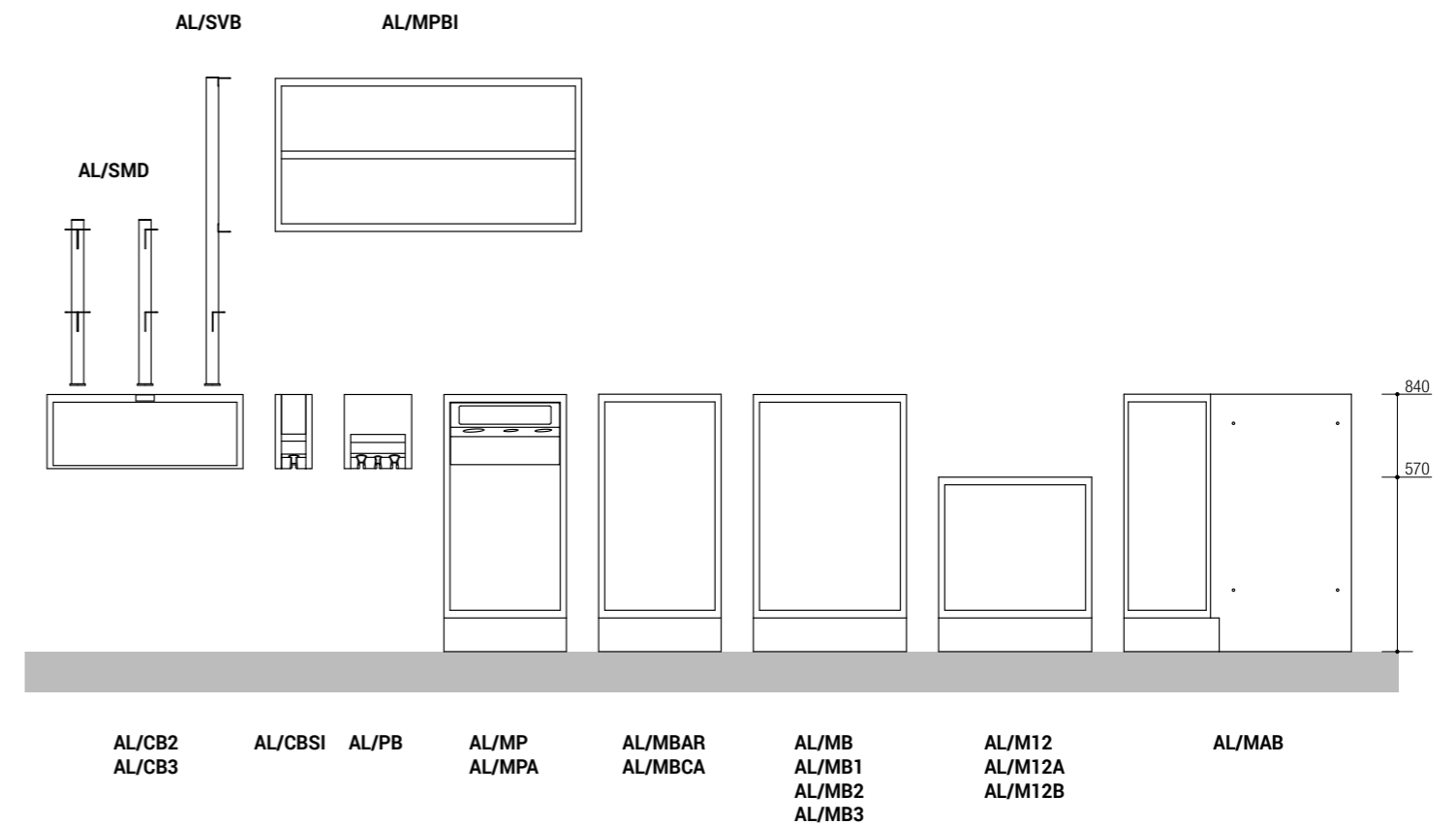
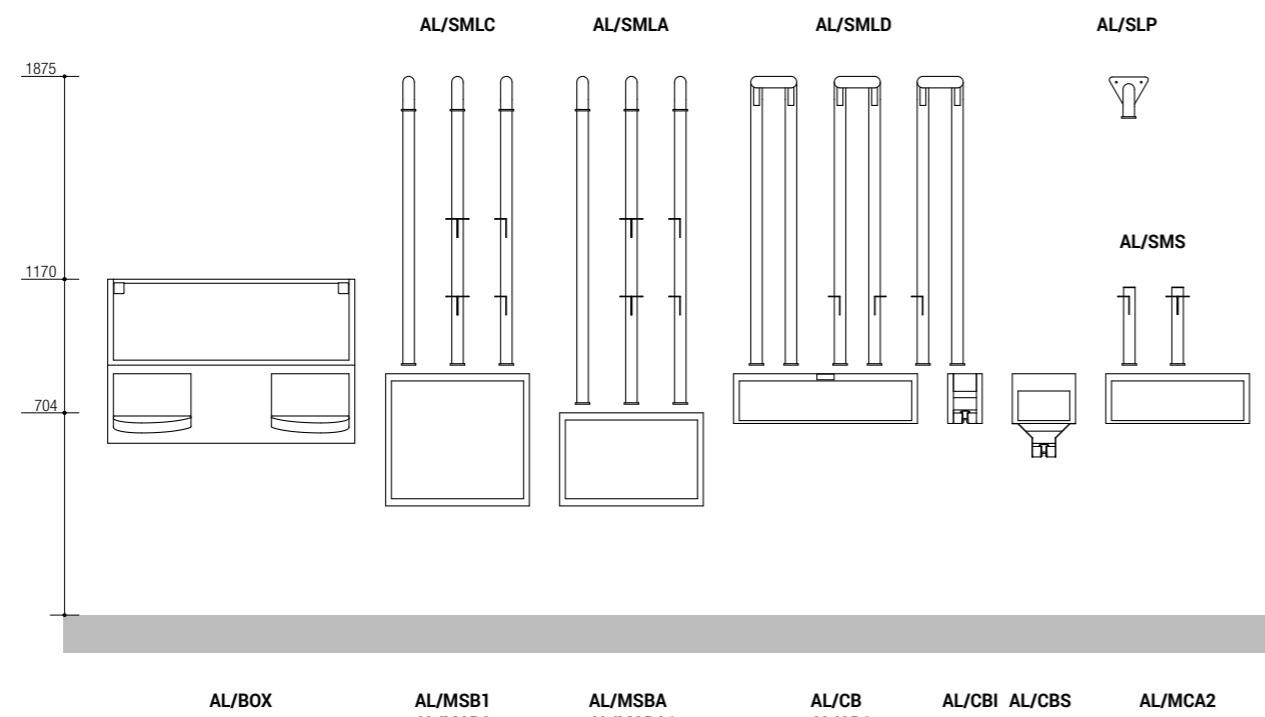

**CARRELLI**

Una gamma di carrelli elettrificati per apparecchiature o semplici carrelli servizio, in metallo verniciato o in acciaio inox 304 con ruote di grandi dimensioni e in gomma morbida.

**TROLLEYS**

A range of electrified trolleys for equipment or simple trolleys, in painted metal or in stainless steel 304 equipped with castors of high dimension in soft rubber.

**Carrello C7**

Altezza 1205 mm  
Profondità 460 mm

**Carrello CE**

Altezza 778 mm  
Profondità 430 mm

**Carrello C1**

Altezza 778 mm  
Profondità 460 mm

**Carrello inox**

Altezza 900 mm  
Profondità 500 mm

**Tavolo mayo**

Altezza 740/1170 mm  
Profondità 450 mm

**Trolley C7**

Height 1205 mm  
Depth 460 mm

**Trolley CE**

Height 778 mm  
Depth 430 mm

**Trolley C1**

Height 778 mm  
Depth 460 mm

**Stainless steel trolley**

Height 900 mm  
Depth 500 mm

**Mayo table**

Height 740/1170 mm  
Depth 450 mm

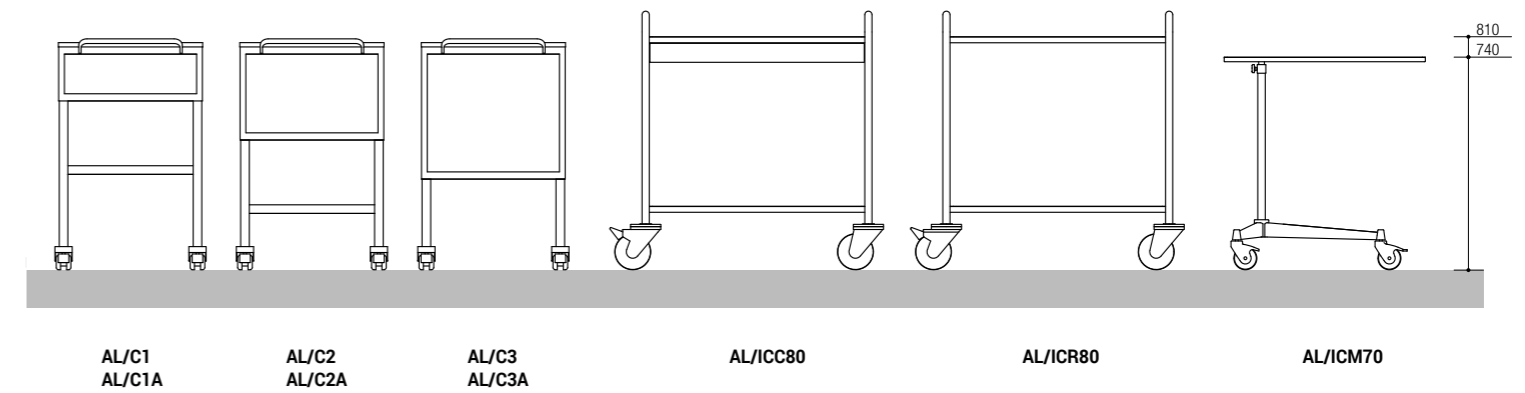
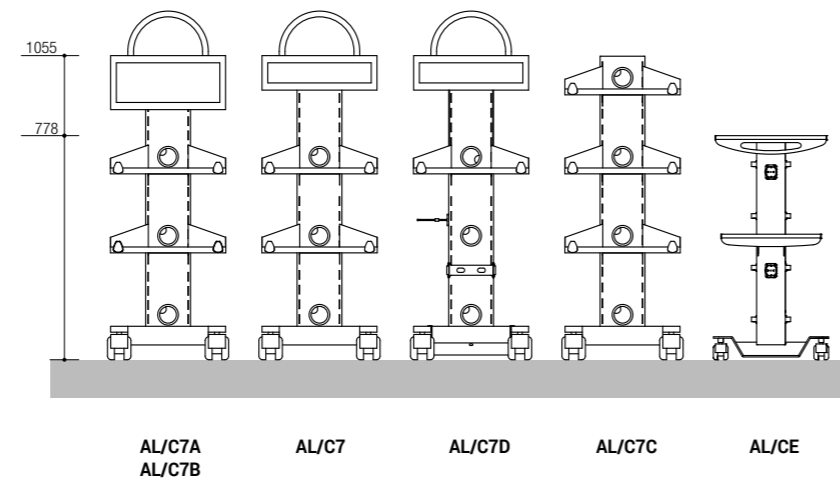

**MOBILI PER LO STOCCAGGIO E INCASSO**

Una gamma di armadi e colonne per stoccaggio, basi e colonne per incasso autoclavi, mobile con frigorifero o lampada germicida, solo in versione con zoccolo.

**UNITS FOR STORAGE AND RECESS**

A range of storage units and tower units for storage, base units and tower units for built-in autoclaves, unit with fridge or germicidal lamp, available with baseboard only.

**Armadio**

Altezza 1900 mm  
Profondità 460/480 mm  
Zoccolo 110 mm

**Armadio a giorno**

Altezza 1900 mm  
Profondità 400 mm  
Zoccolo 110 mm

**Mobili**

Altezza 840 mm  
Profondità 460/560 mm  
Zoccolo 110 mm

**Colonna**

Altezza 1370 mm  
Profondità 560 mm  
Zoccolo 110 mm

**Storage unit**

Height 1900 mm  
Depth 460/480 mm  
Baseboard 110 mm

**Open storage unit**

Height 1900 mm  
Depth 400 mm  
Baseboard 110 mm

**Base units**

Height 840 mm  
Depth 460/560 mm  
Baseboard 110 mm

**Tower unit**

Height 1370 mm  
Depth 560 mm  
Baseboard 110 mm

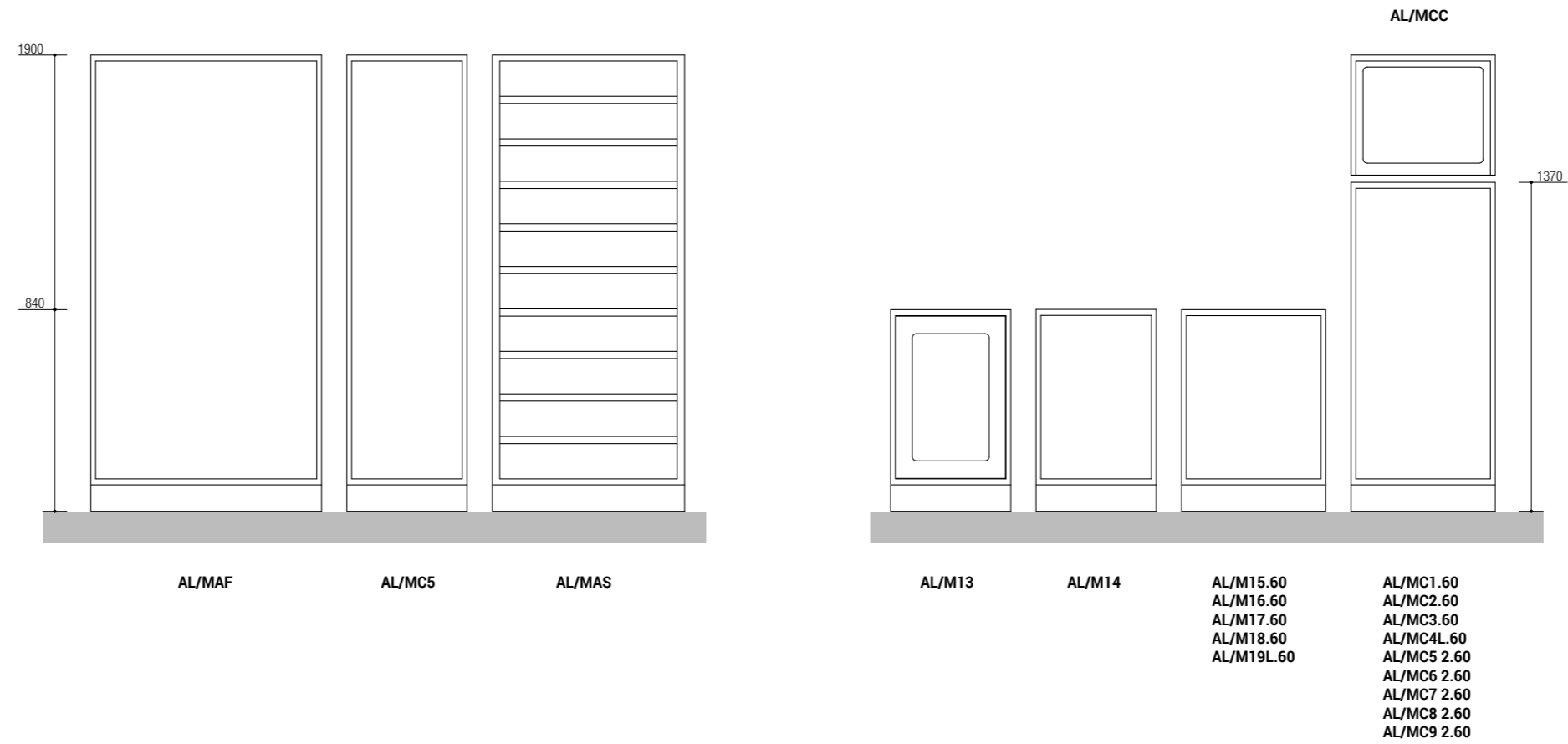



**Schema posizionamento impiantistica nel mobile lavello.**  
**Diagram of the positioning of the plants in the unit for sink.**

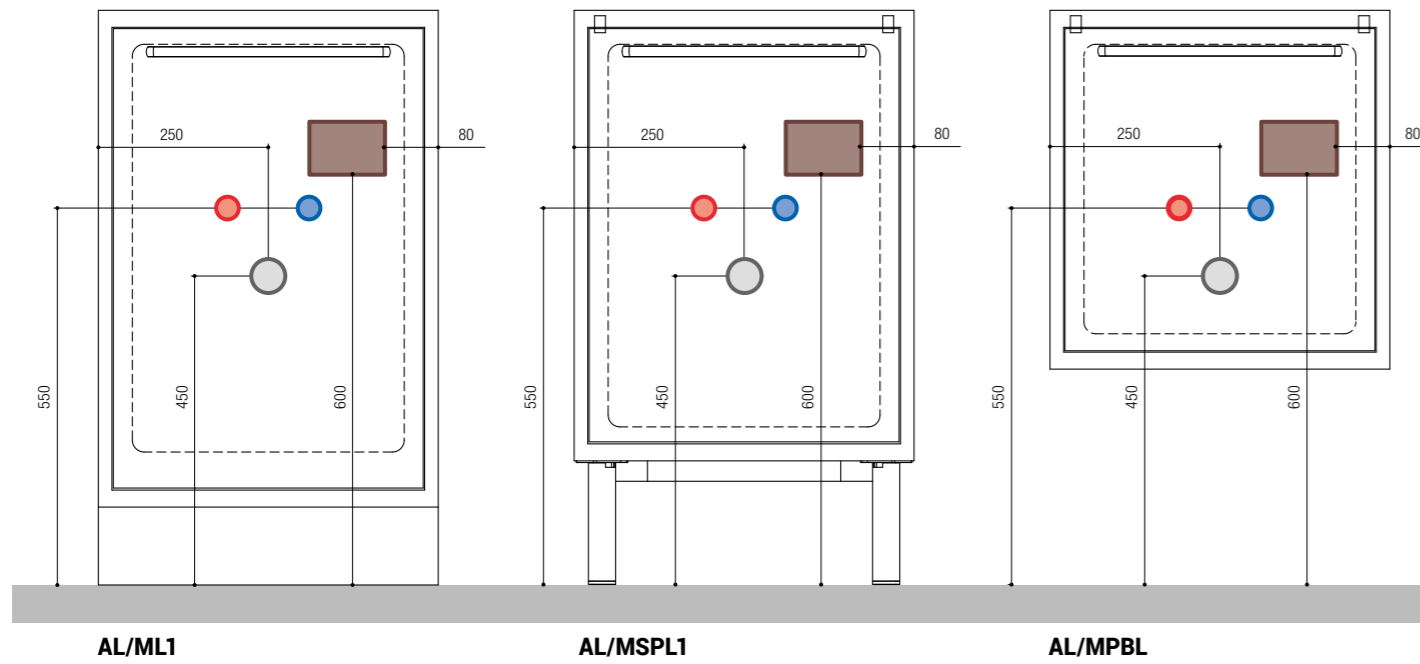

**Schema posizionamento impiantistica mobile lavello doppio.**  
**Diagram of the positioning of the plants in the unit for double sink.**

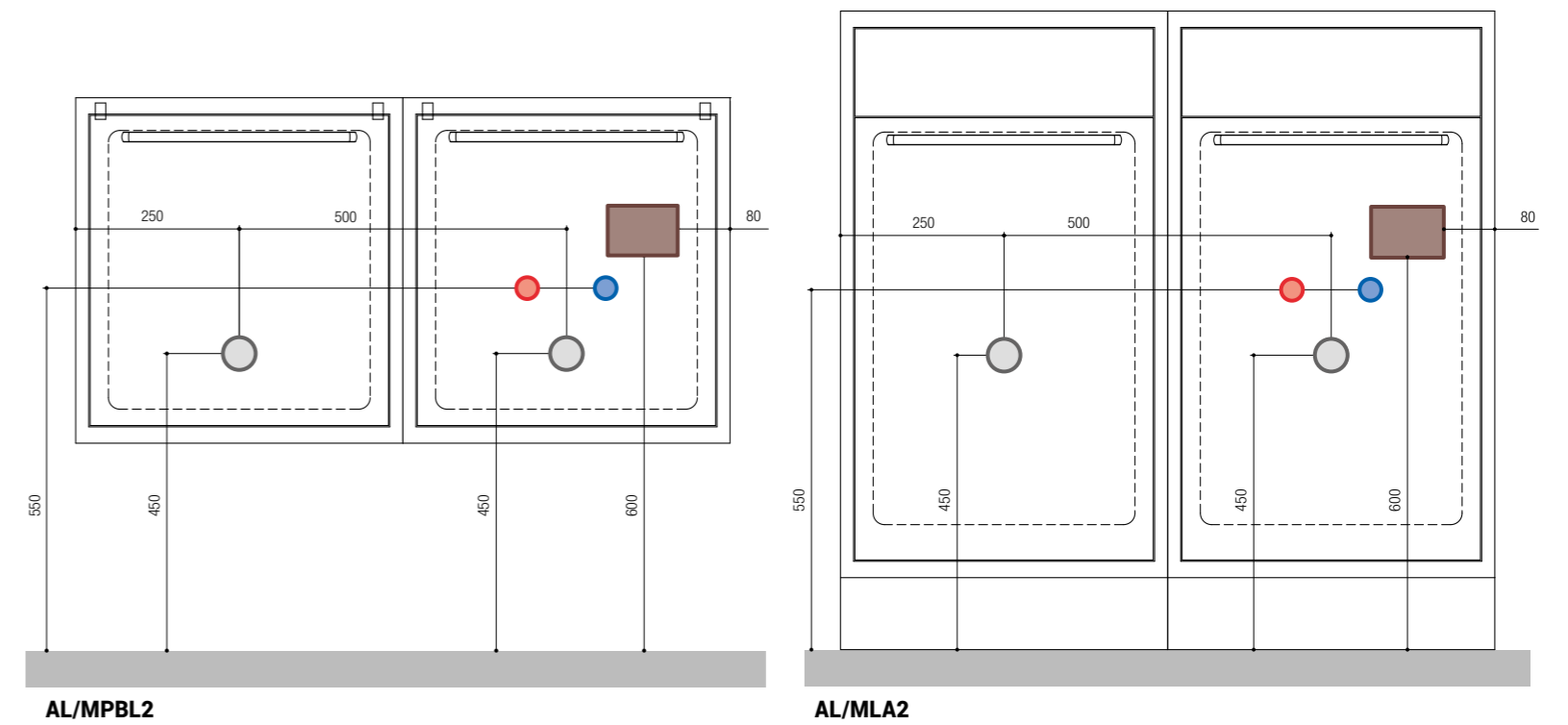
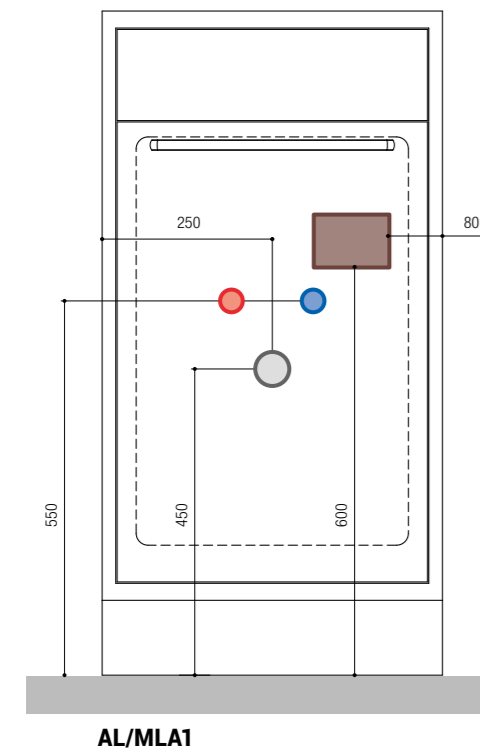
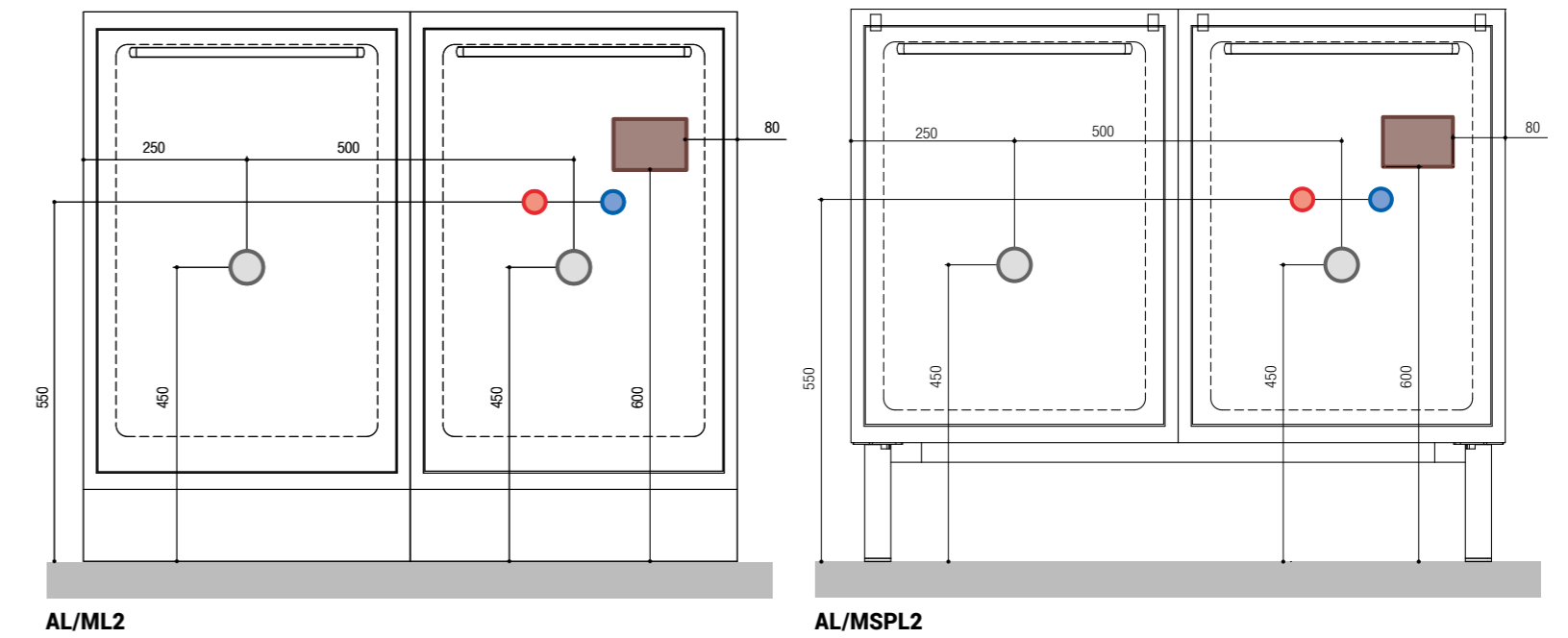

**Legenda colori / Colour legend**

- |                 |                           |                         |            |           |                 |                          |                |
|-----------------|---------------------------|-------------------------|------------|-----------|-----------------|--------------------------|----------------|
| Scarico / Drain | Acqua fredda / Cold water | Acqua calda / Hot water | Aria / Air | Gas / Gas | Motrice / Power | Illuminazione / Lighting | Dati / Network |
|-----------------|---------------------------|-------------------------|------------|-----------|-----------------|--------------------------|----------------|

**Legenda colori / Colour legend**

- |                 |                           |                         |            |           |                 |                          |                |
|-----------------|---------------------------|-------------------------|------------|-----------|-----------------|--------------------------|----------------|
| Scarico / Drain | Acqua fredda / Cold water | Acqua calda / Hot water | Aria / Air | Gas / Gas | Motrice / Power | Illuminazione / Lighting | Dati / Network |
|-----------------|---------------------------|-------------------------|------------|-----------|-----------------|--------------------------|----------------|

**Schema posizionamento impiantistica nel mobile livello angolare.**  
**Diagram of the positioning of the plants in the corner unit for sink.**

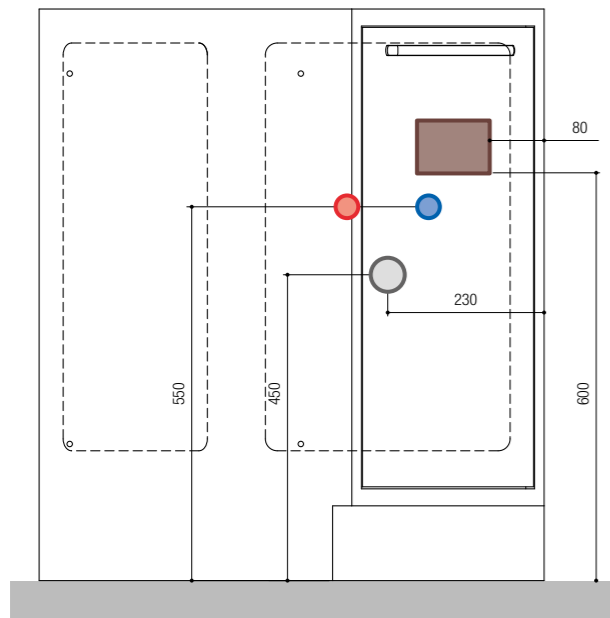

AL/MAL3

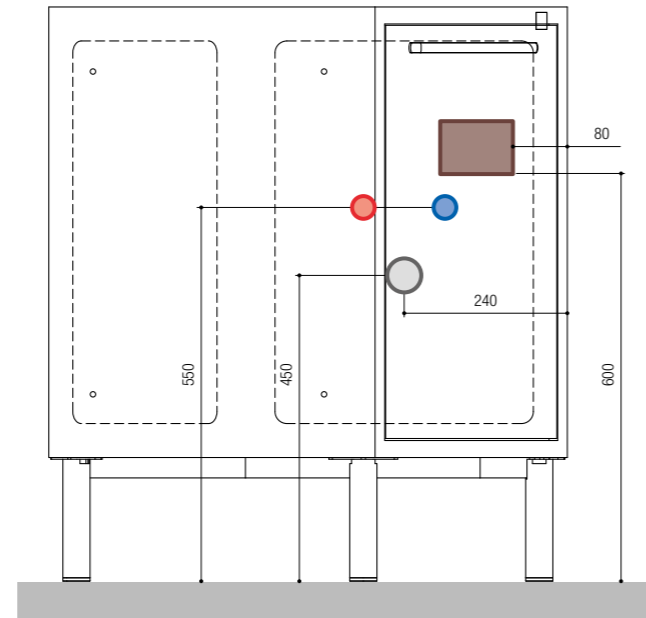

AL/MASPL3

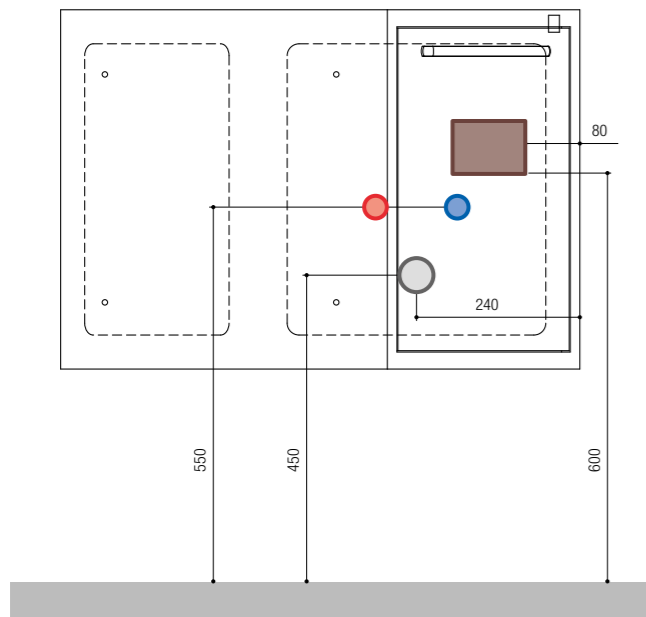

AL/MPBAL

**Legenda colori / Colour legend**

- Scarico / Drain
- Acqua fredda / Cold water
- Acqua calda / Hot water
- Aria / Air
- Gas / Gas
- Motrice / Power
- Illuminazione / Lighting
- Dati / Network

**Schema posizionamento impiantistica nel mobile Pc da 30.**

**Diagram of the positioning of the plants in the Pc unit of 30.**

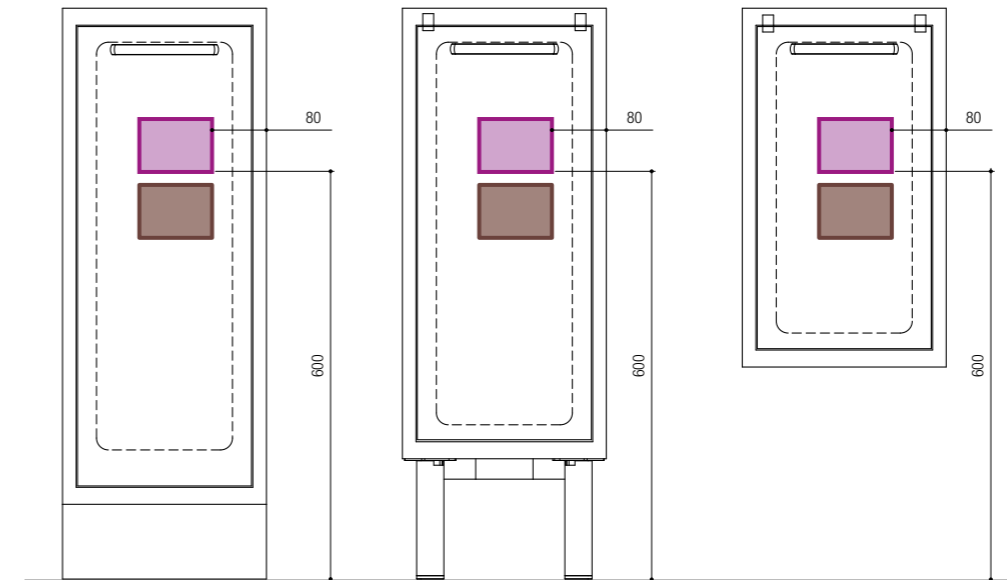

AL/M1.30PC

AL/MSP1.30PC

AL/MPB1.30PC

**Schema posizionamento impiantistica nel mobile Pc da 40.**

**Diagram of the positioning of the plants in the Pc unit of 40.**

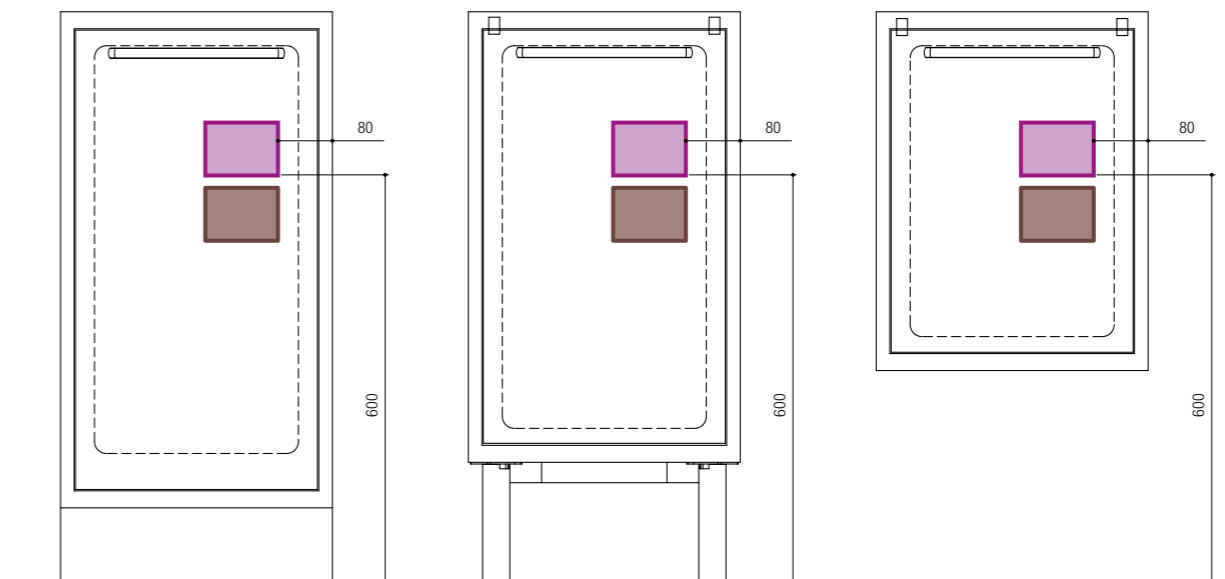

AL/M1.40PC

AL/MSP1.40PC

AL/MPB1.40PC

**Schema posizionamento impiantistica nel mobile Pc da 50.**

**Diagram of the positioning of the plants in the Pc unit of 50.**



AL/MPC

AL/MSPPC

**Legenda colori / Colour legend**

- Scarico / Drain
- Acqua fredda / Cold water
- Acqua calda / Hot water
- Aria / Air
- Gas / Gas
- Motrice / Power
- Illuminazione / Lighting
- Dati / Network

Schema posizionamento impiantistica nei mobili base e colonne.  
Diagram of the positioning of the plants in the units and tower units.

Schema posizionamento impiantistica nei mobili base e colonne.  
Diagram of the positioning of the plants in the units and tower units.

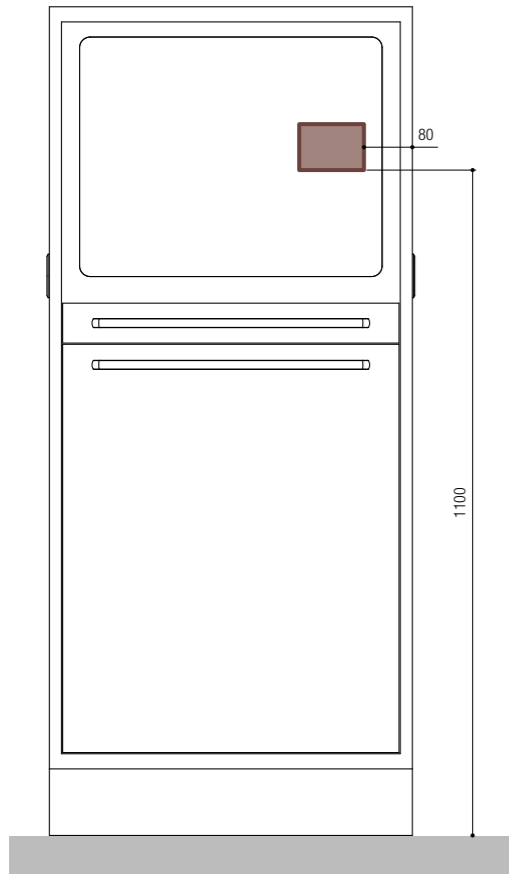

AL/MC1.60

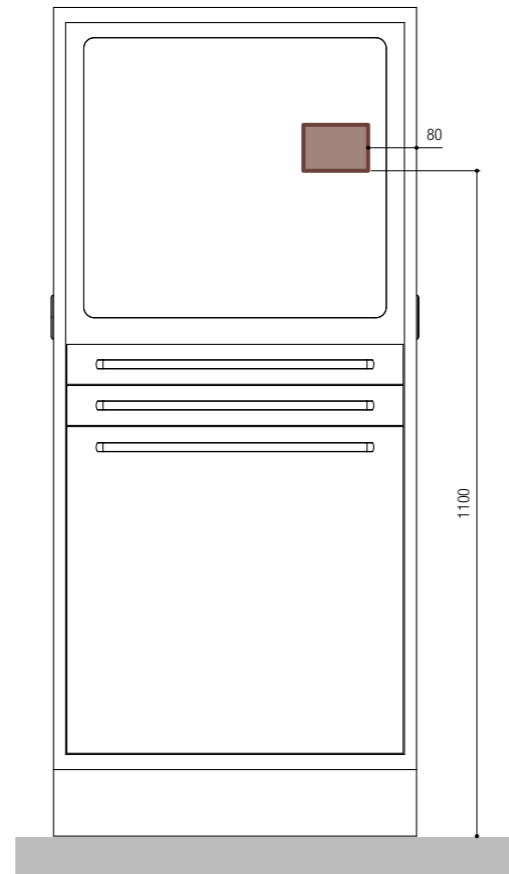

AL/MC2.60

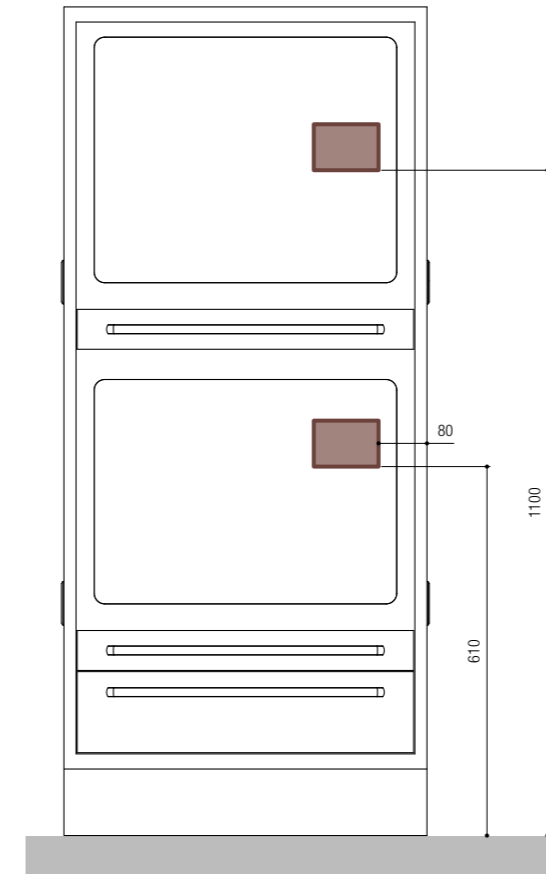

AL/MC5 2.60

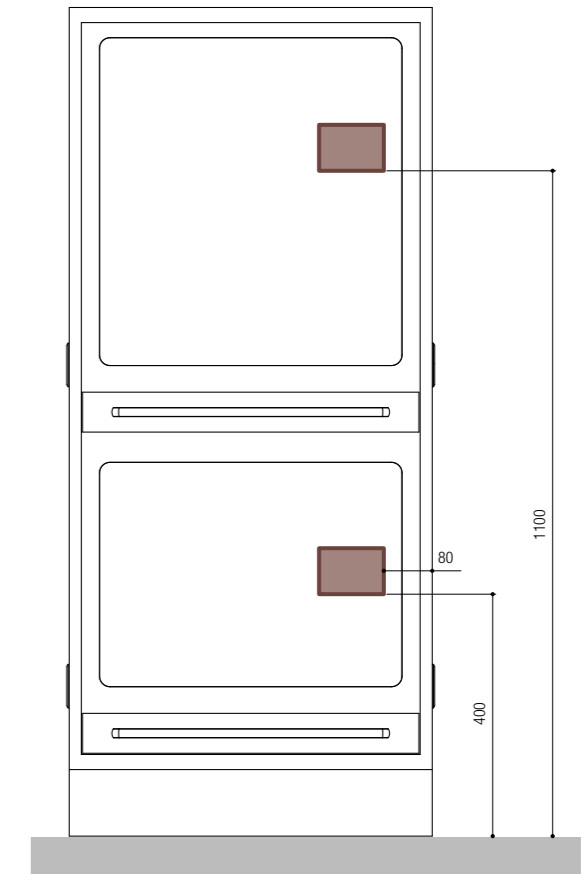

AL/MC6 2.60

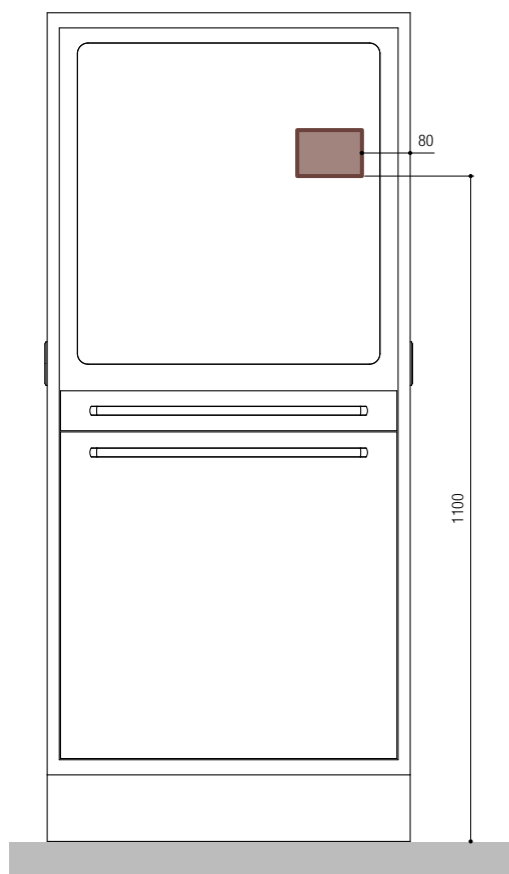

AL/MC3.60

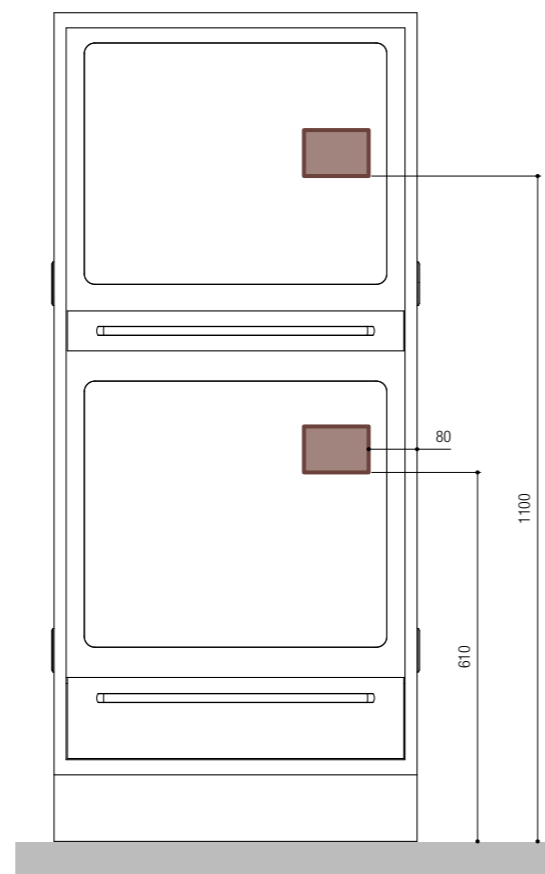

AL/MC4.60

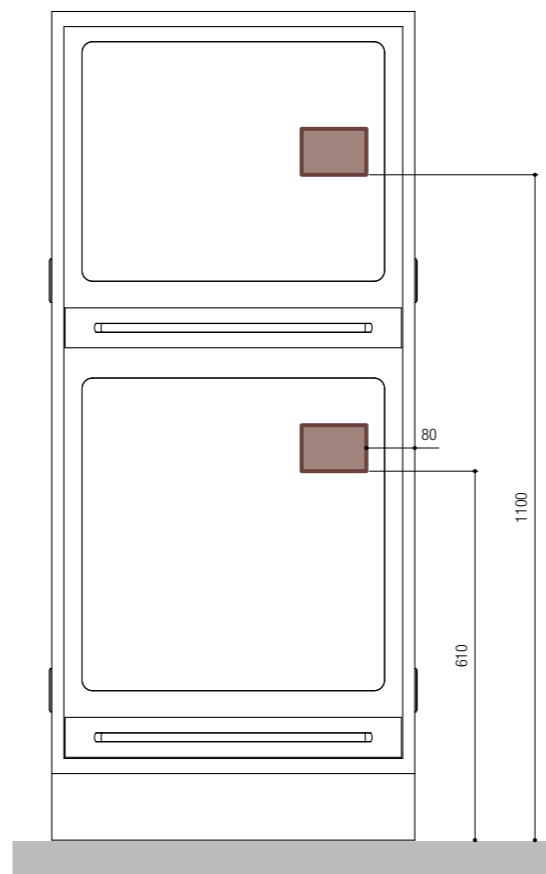

AL/MC7 2.60

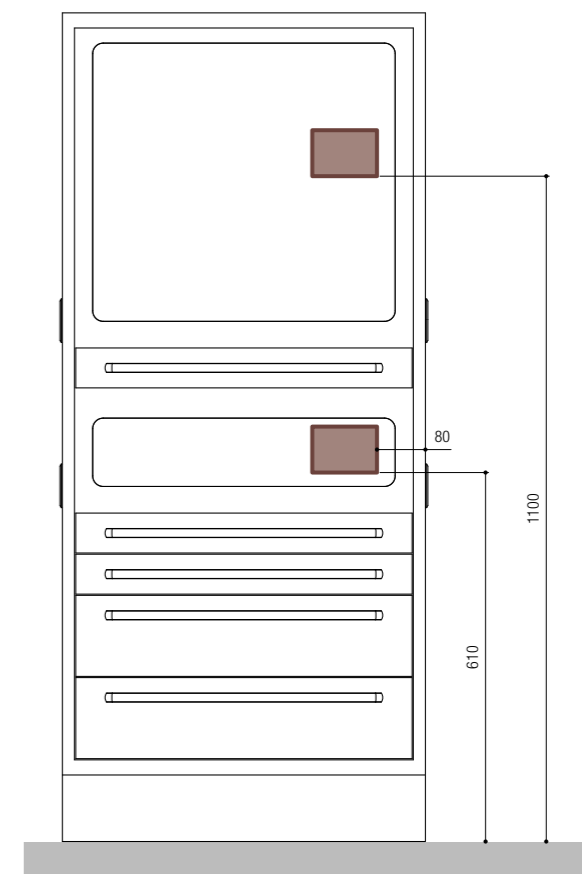

AL/MC8 2.60

Legenda colori / Colour legend

- Scarico / Drain
- Acqua fredda / Cold water
- Acqua calda / Hot water
- Aria / Air
- Gas / Gas
- Motrice / Power
- Illuminazione / Lighting
- Dati / Network

Legenda colori / Colour legend

- Scarico / Drain
- Acqua fredda / Cold water
- Acqua calda / Hot water
- Aria / Air
- Gas / Gas
- Motrice / Power
- Illuminazione / Lighting
- Dati / Network

Schema posizionamento impiantistica nei mobili base e colonne.  
Diagram of the positioning of the plants in the units and tower units.

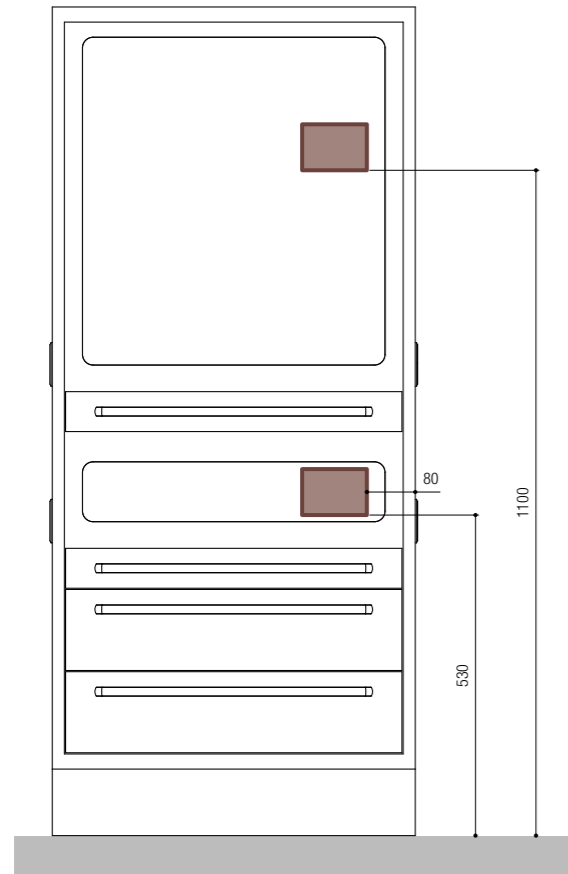

AL/MC9 2.60

Schema posizionamento impiantistica nei mobili base e colonne.  
Diagram of the positioning of the plants in the units and tower units.

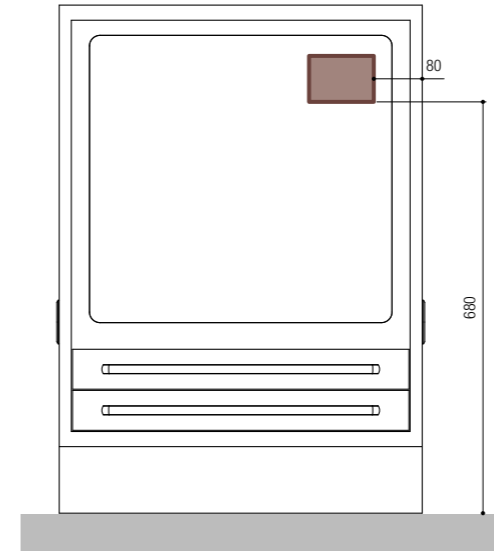

AL/M17.60

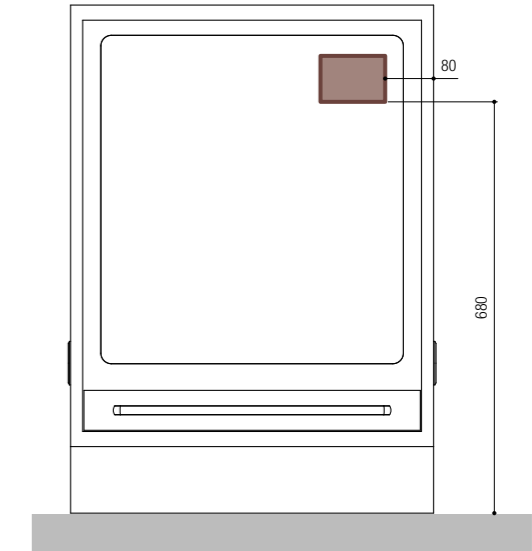

AL/M18.60

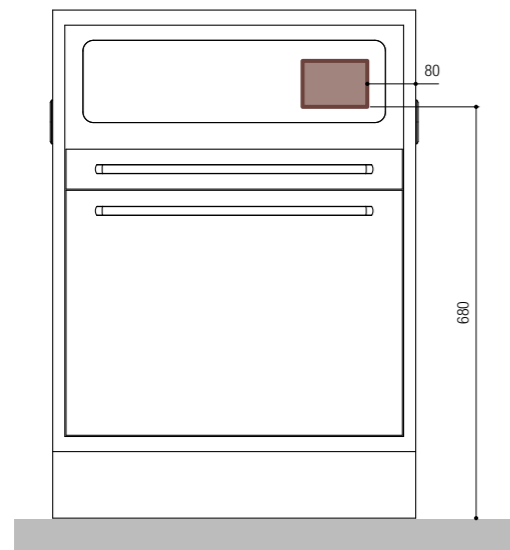

AL/M15.60

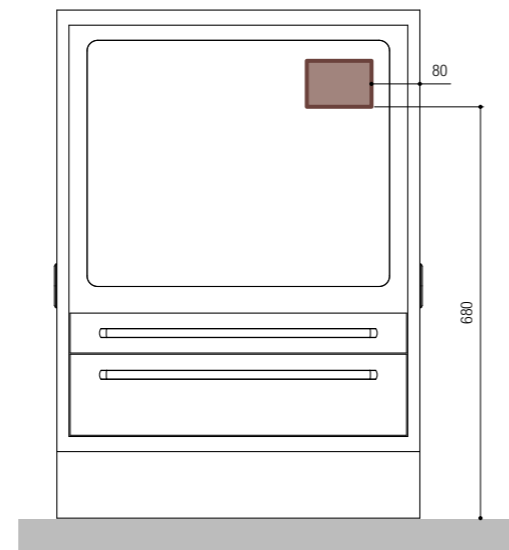

AL/M16.60

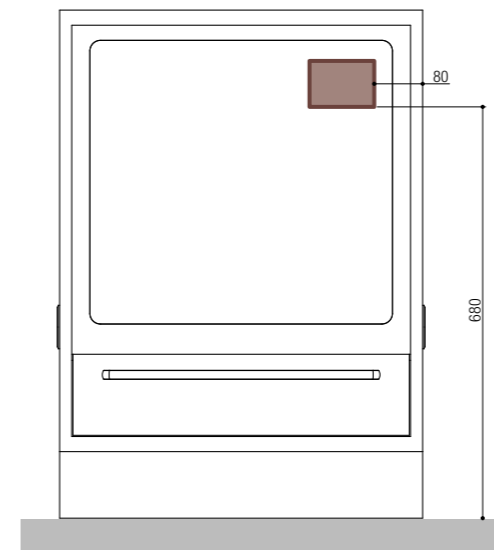

AL/M19L.60

Legenda colori / Colour legend

- Scarico / Drain
- Acqua fredda / Cold water
- Acqua calda / Hot water
- Aria / Air
- Gas / Gas
- Motrice / Power
- Illuminazione / Lighting
- Dati / Network

Legenda colori / Colour legend

- Scarico / Drain
- Acqua fredda / Cold water
- Acqua calda / Hot water
- Aria / Air
- Gas / Gas
- Motrice / Power
- Illuminazione / Lighting
- Dati / Network

Esempio di simulazione impiantistica da realizzare per una composizione studio.  
 Example of plant simulation to be realized in a composition for the practice.

Esempio di simulazione impiantistica da realizzare per una composizione studio.  
 Example of plant simulation to be realized in a composition for the practice.

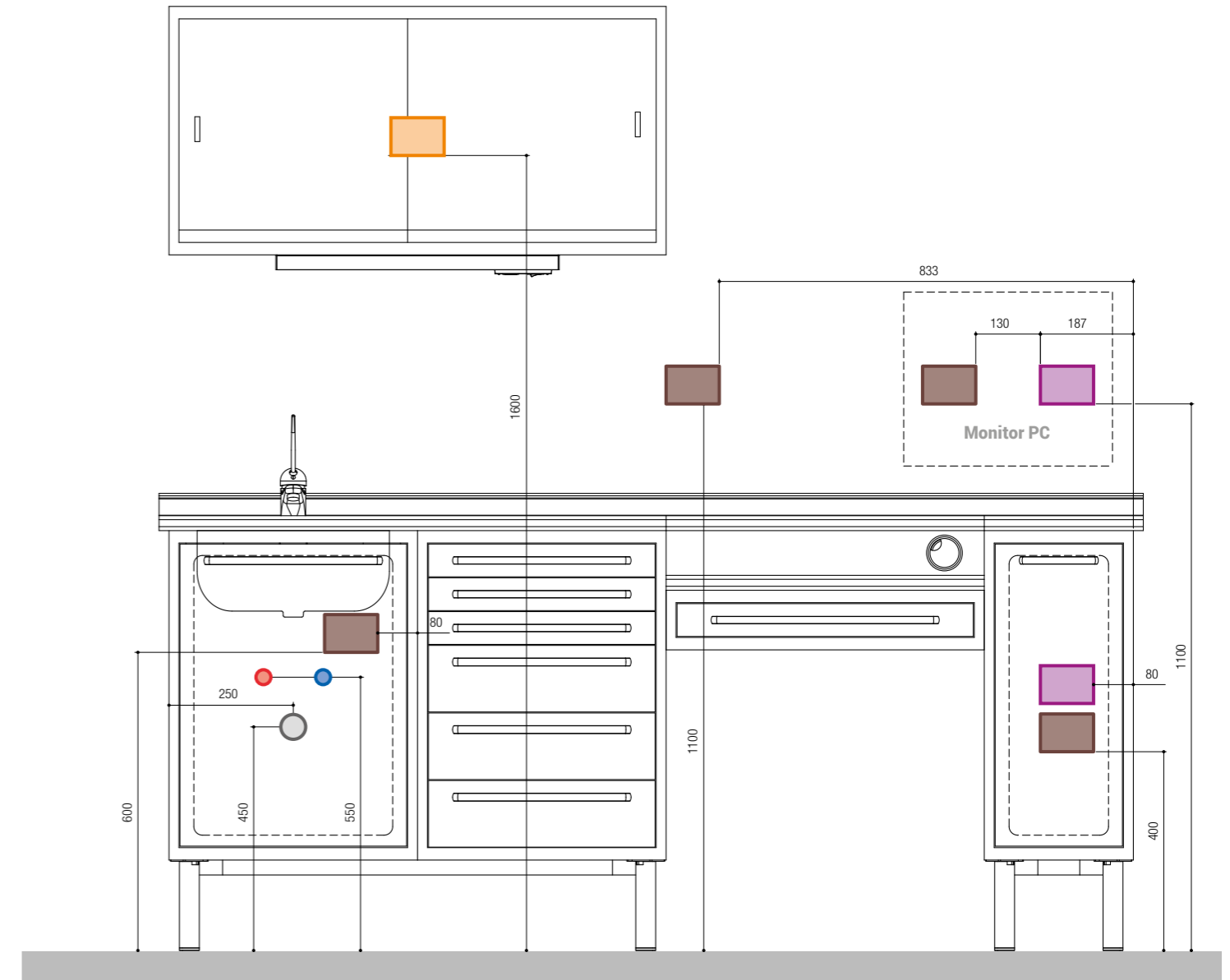
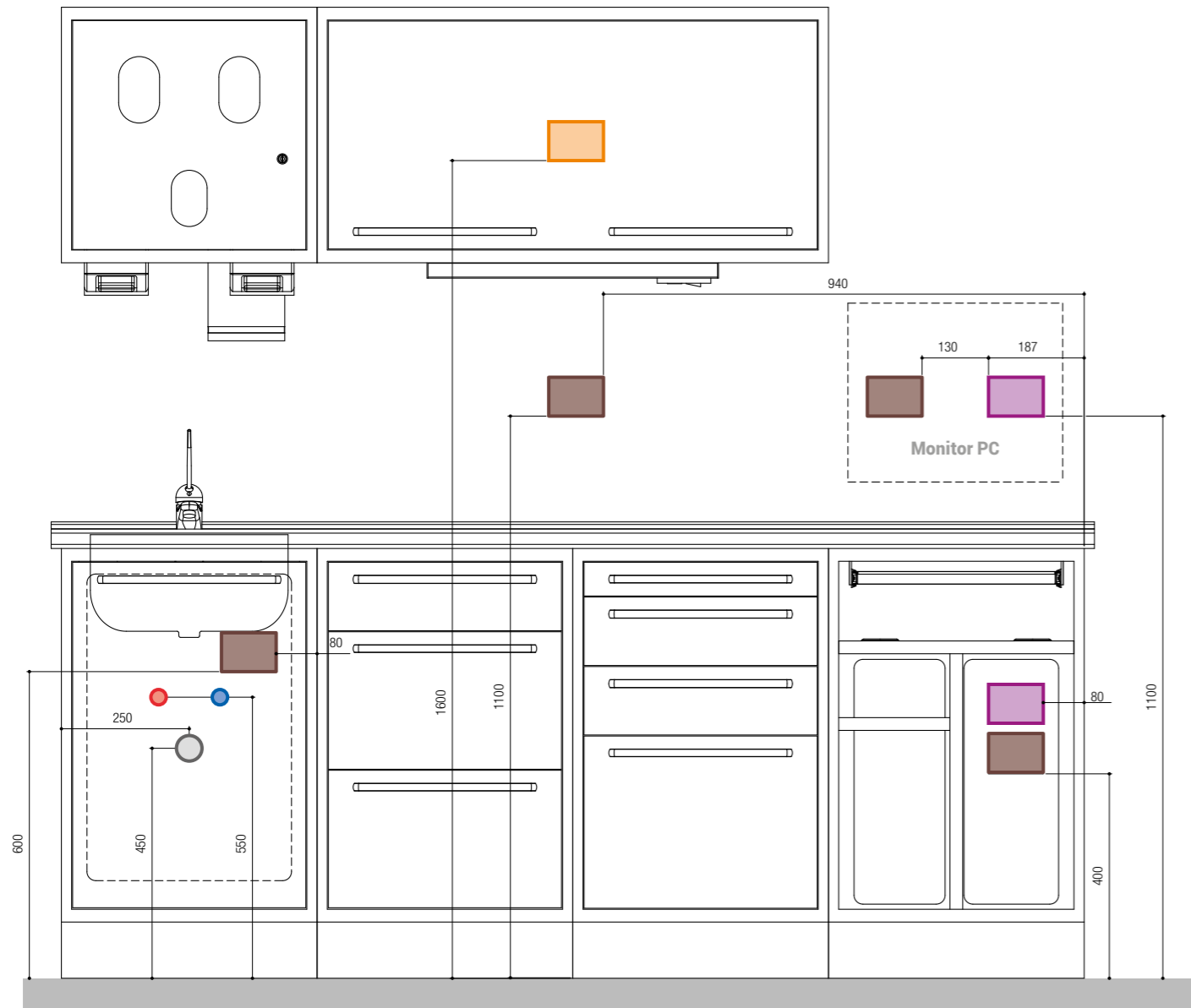

Legenda colori / Colour legend

- Scarico / Drain
- Acqua fredda / Cold water
- Acqua calda / Hot water
- Aria / Air
- Gas / Gas
- Motrice / Power
- Illuminazione / Lighting
- Dati / Network

Legenda colori / Colour legend

- Scarico / Drain
- Acqua fredda / Cold water
- Acqua calda / Hot water
- Aria / Air
- Gas / Gas
- Motrice / Power
- Illuminazione / Lighting
- Dati / Network

Esempio di simulazione impiantistica da realizzare per una composizione lato sporco della sterilizzazione.  
 Example of plant simulation to be realized in a composition for the dirty side of the sterilization room.

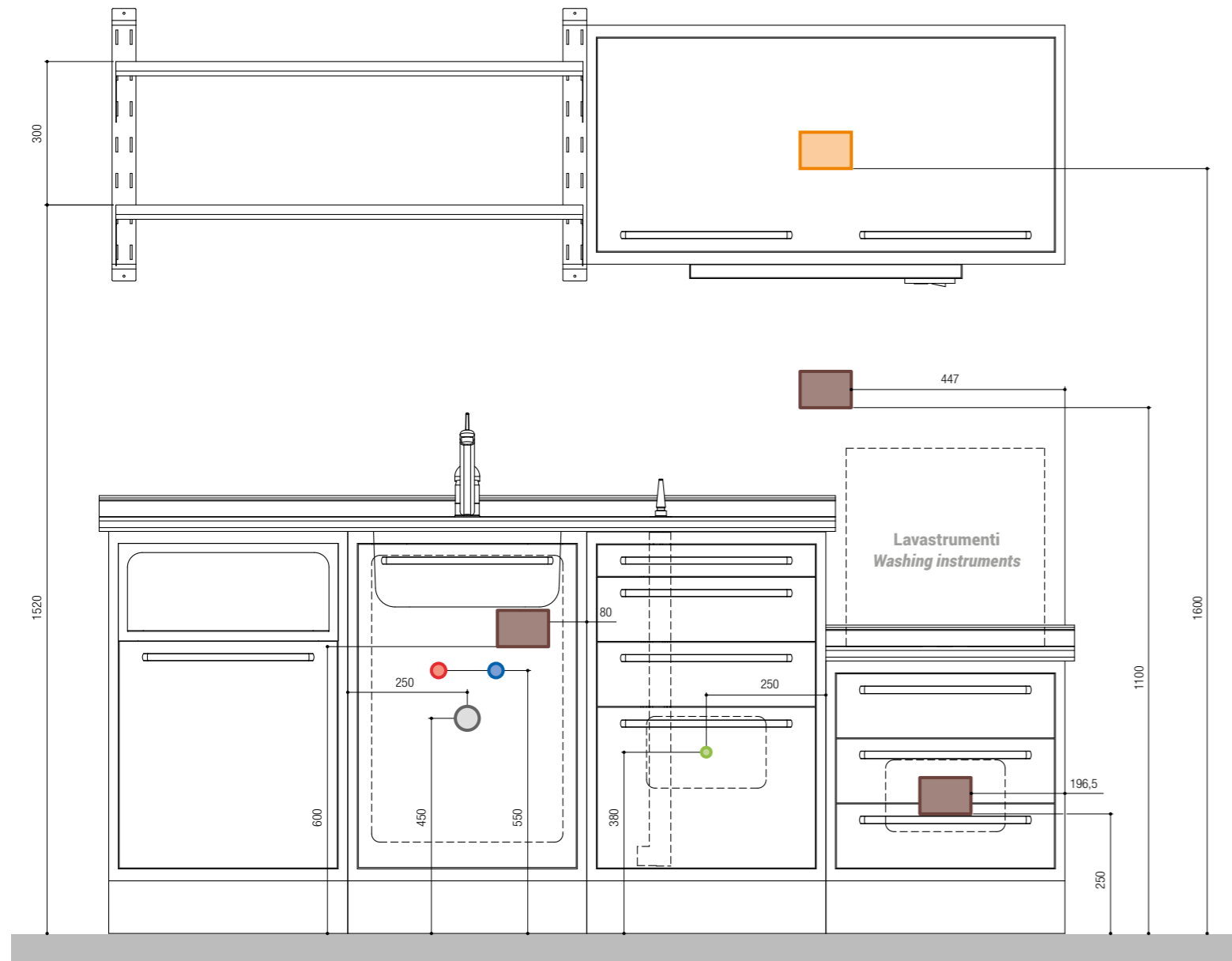

**Legenda colori / Colour legend**

● Scarico Drain	● Acqua fredda Cold water	● Acqua calda Hot water	● Aria Air	● Gas Gas	● Motrice Power	● Illuminazione Lighting	● Dati Network
--------------------	------------------------------	----------------------------	---------------	--------------	--------------------	-----------------------------	-------------------

Esempio di simulazione impiantistica da realizzare per una composizione lato pulito della sterilizzazione.  
 Example of plant simulation to be realized in a composition for the clean side of the sterilization room.

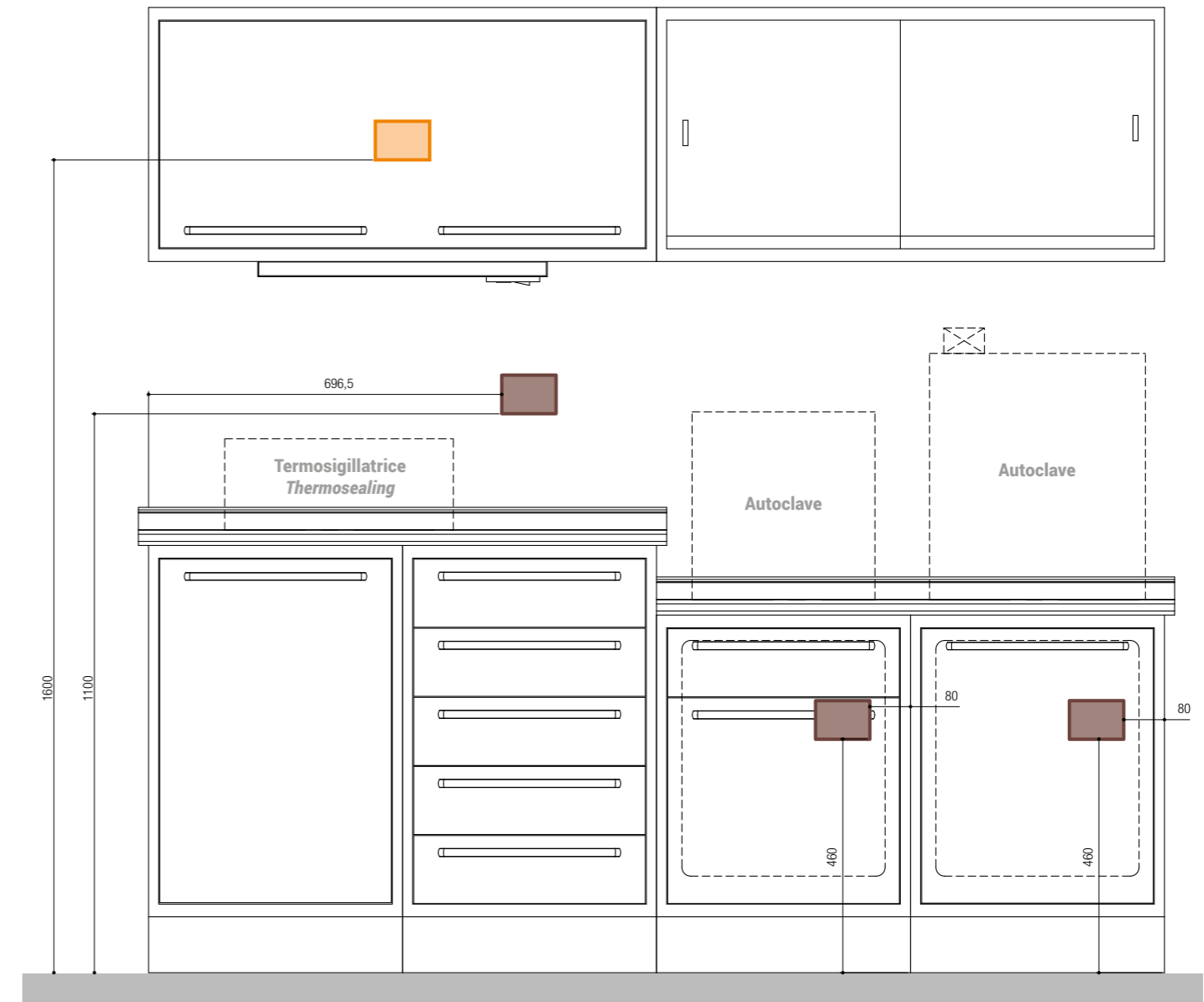

**Legenda colori / Colour legend**

● Scarico Drain	● Acqua fredda Cold water	● Acqua calda Hot water	● Aria Air	● Gas Gas	● Motrice Power	● Illuminazione Lighting	● Dati Network
--------------------	------------------------------	----------------------------	---------------	--------------	--------------------	-----------------------------	-------------------

**Esempio di simulazione impiantistica da realizzare per una composizione lato sporco della sterilizzazione.**  
*Example of plant simulation to be realized in a composition for the dirty side of the sterilization room.*

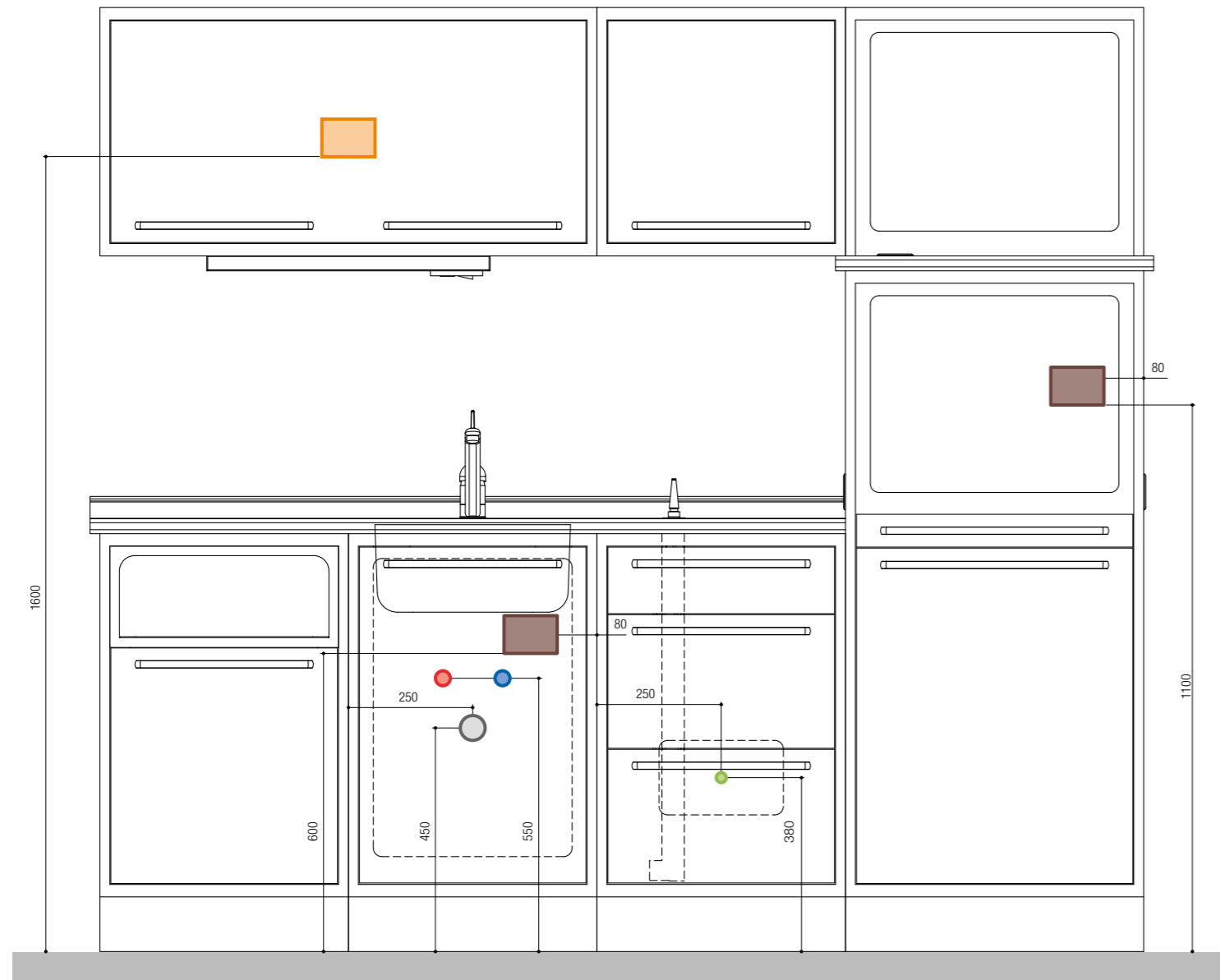

Legenda colori / Colour legend							
Scarico / Drain	Acqua fredda / Cold water	Acqua calda / Hot water	Aria / Air	Gas / Gas	Motrice / Power	Illuminazione / Lighting	Dati / Network

**Esempio di simulazione impiantistica da realizzare per una composizione lato pulito della sterilizzazione.**  
*Example of plant simulation to be realized in a composition for the clean side of the sterilization room.*

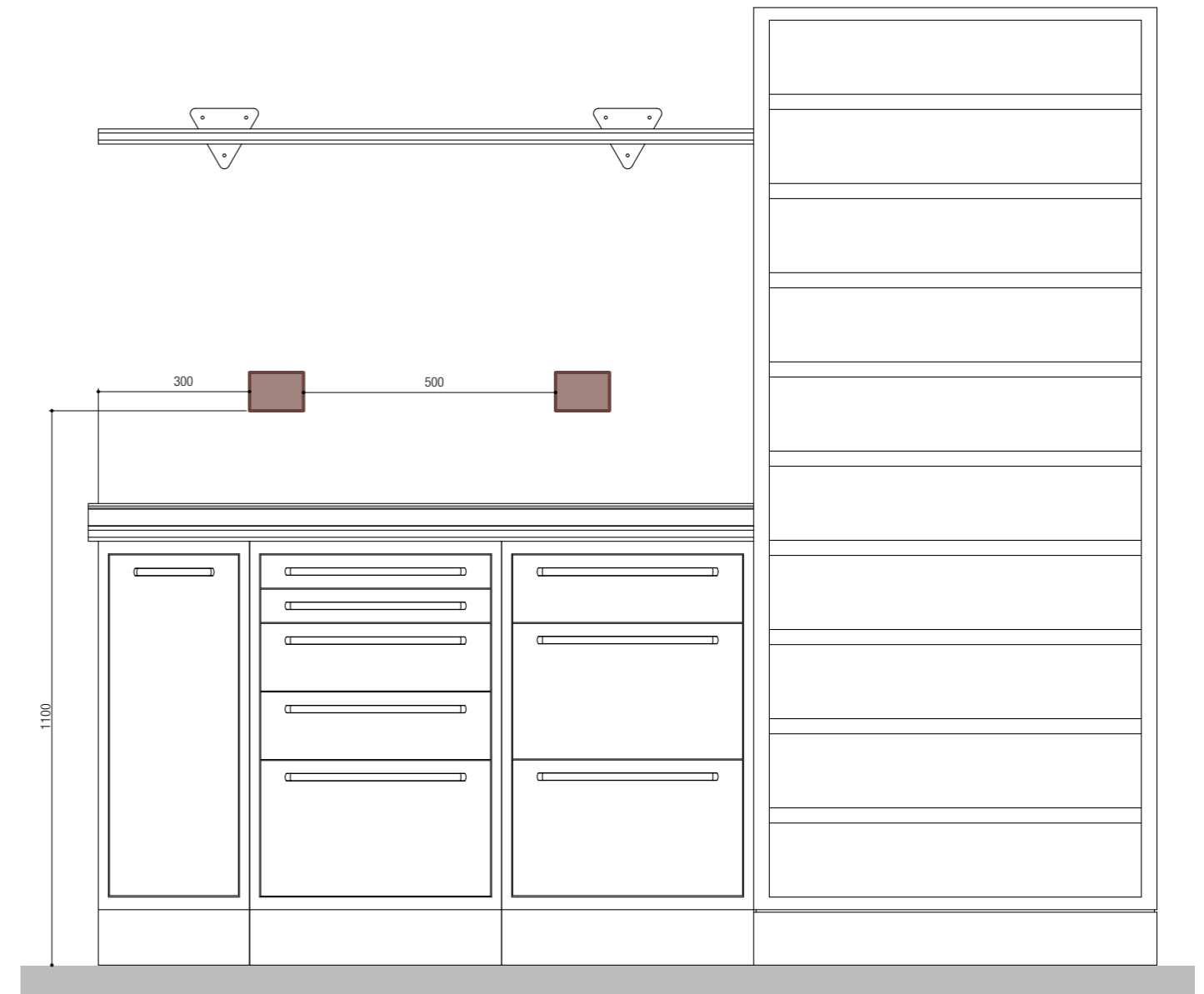

Legenda colori / Colour legend							
Scarico / Drain	Acqua fredda / Cold water	Acqua calda / Hot water	Aria / Air	Gas / Gas	Motrice / Power	Illuminazione / Lighting	Dati / Network

**Esempio simulazione impiantistica da realizzare per una composizione zona gessi.**  
**Example of plant simulation to be realized in a composition with plaster zone.**

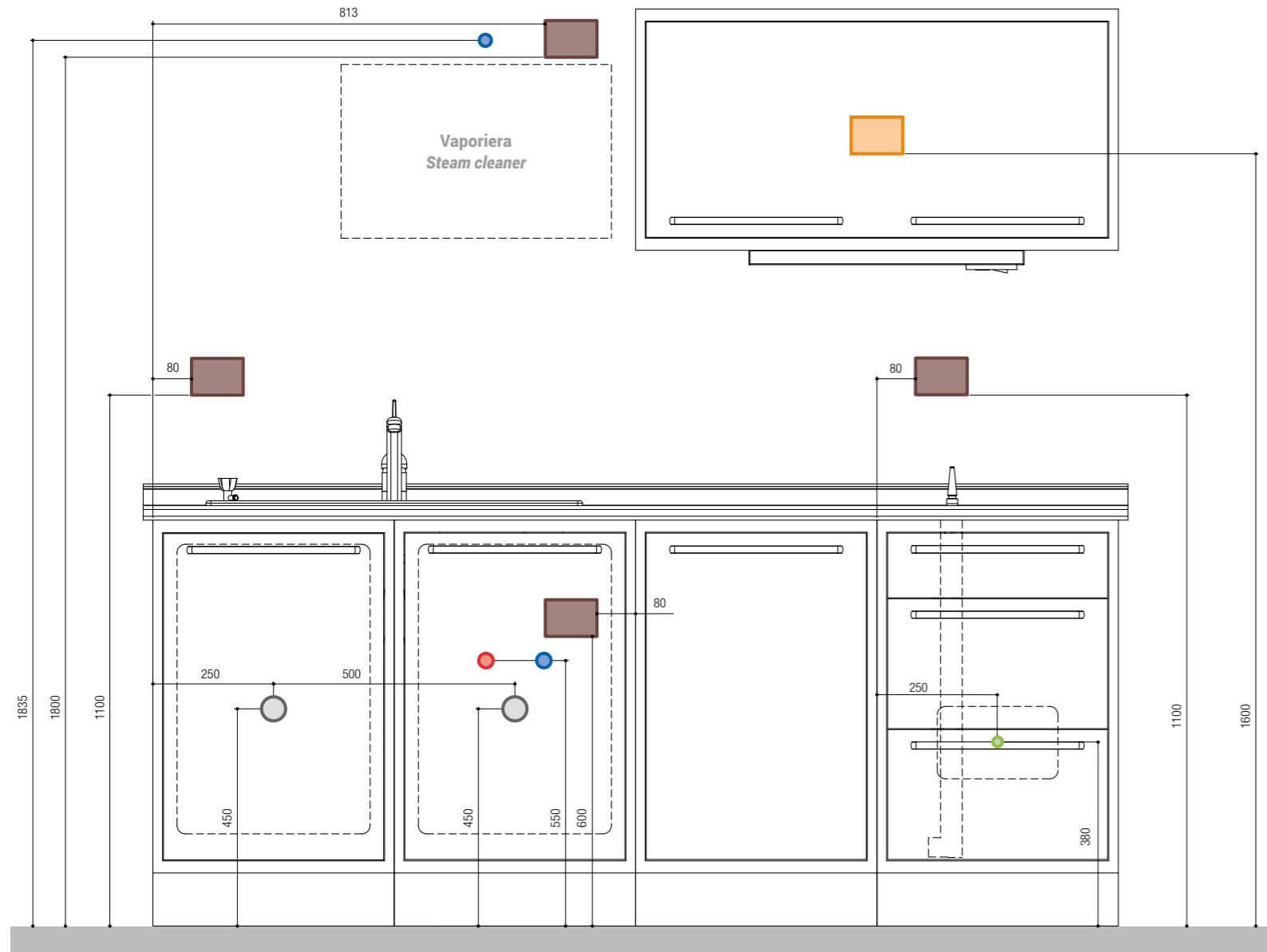

**Legenda colori / Colour legend**

- |                  |                            |                          |             |            |                  |                           |                 |
|------------------|----------------------------|--------------------------|-------------|------------|------------------|---------------------------|-----------------|
| Scarico<br>Drain | Acqua fredda<br>Cold water | Acqua calda<br>Hot water | Aria<br>Air | Gas<br>Gas | Motrice<br>Power | Illuminazione<br>Lighting | Dati<br>Network |
|------------------|----------------------------|--------------------------|-------------|------------|------------------|---------------------------|-----------------|

**Esempio simulazione impiantistica da realizzare per composizione banco laboratorio.**  
**Example of plant simulation to be realized in a composition for the laboratory bench.**

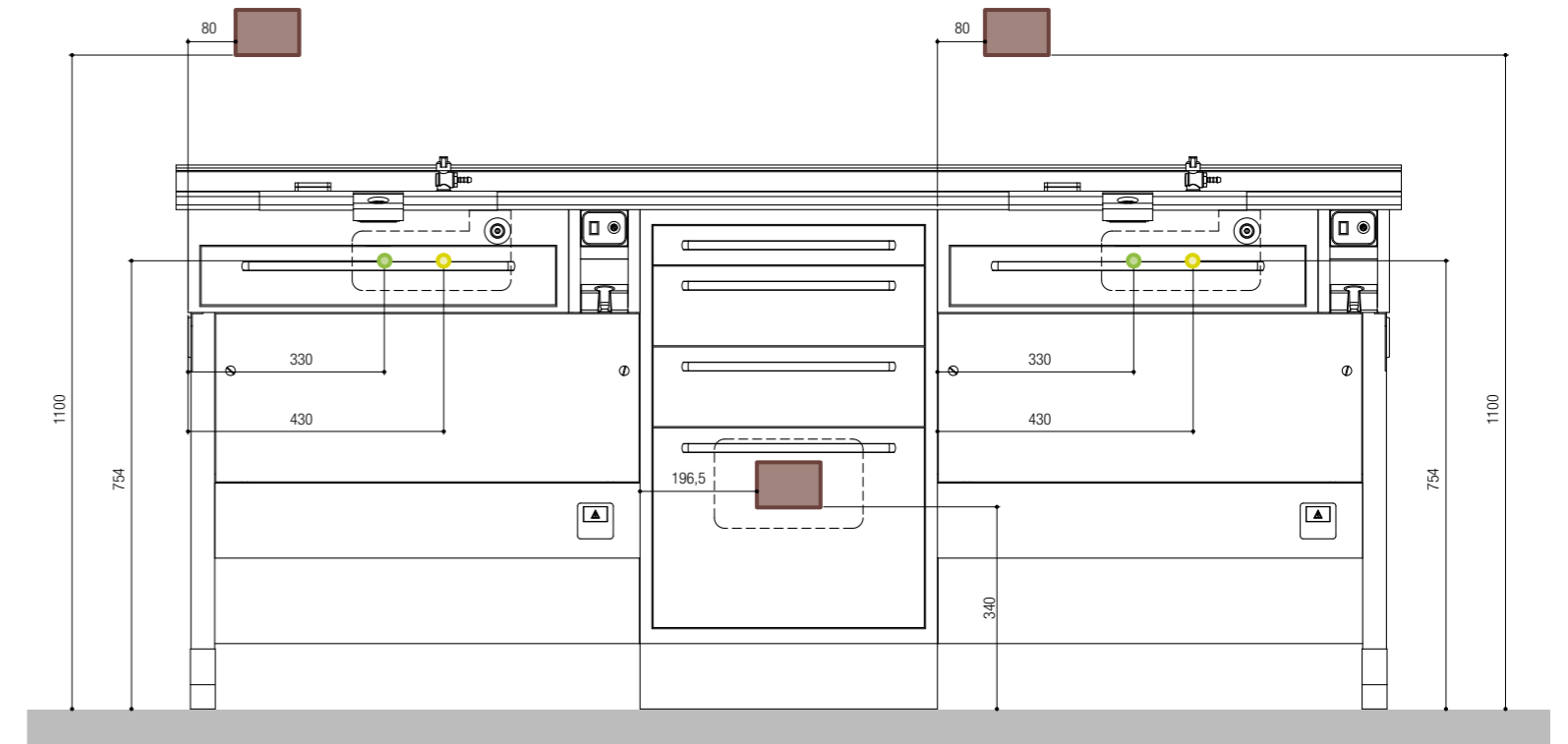

**Legenda colori / Colour legend**

- |                  |                            |                          |             |            |                  |                           |                 |
|------------------|----------------------------|--------------------------|-------------|------------|------------------|---------------------------|-----------------|
| Scarico<br>Drain | Acqua fredda<br>Cold water | Acqua calda<br>Hot water | Aria<br>Air | Gas<br>Gas | Motrice<br>Power | Illuminazione<br>Lighting | Dati<br>Network |
|------------------|----------------------------|--------------------------|-------------|------------|------------------|---------------------------|-----------------|





MOBILI METALLICI

EC - Declaration of conformity  
Dichiarazione di conformità con le norme CE  
EG - Konformitätserklärung  
CE – Déclaration de conformité  
Prohlášení o shodě s normami ES  
Declaración de Conformidad de la CE

## STYL FRIGO s.n.c.

Via Luigi Galvani 8/10  
33083 CHIONS (PN) ITALY

### Electrified Equipment

2006/95/EC  
2004/108/EC

EC Low Voltage Directive  
EMC Directive



We declare that the products manufactured by us to which this statement refers, conform to the essential requirements according to the above mentioned directive.



Dichiariamo che i prodotti da noi fabbricati, a cui si riferisce la presente dichiarazione, sono conformi ai requisiti fondamentali ai sensi delle disposizioni della direttiva summenzionata.



Wir erklären, dass die von uns hergestellten Produkte auf die sich diese Erklärung bezieht, mit den grundlegenden Anforderungen gemäß den Bestimmungen der obigen Richtlinie übereinstimmen.



Nous déclarons que les produits que nous fabriquons, auxquels se réfère cette déclaration, sont conformes aux exigences essentielles selon les dispositions de la directive susmentionnée.



Prohlašujeme, že se námi vyráběné výrobky, na které se vztahuje toto prohlášení, shodují se základními požadavky podle předpisů výše uvedené směrnice.



Por la presente declaramos que los productos que nosotros fabricamos, y a los que hace referencia esta declaración, cumplen los requisitos básicos de conformidad con las disposiciones de la directica arriba mencionada.

Chions  
Effective date 10.6.2011



Manias Giorgio.  
(Legally Authorised Representative)

Design & progetto:  
**Ufficio tecnico Astra**  
[www.astrastyl.it](http://www.astrastyl.it)

Rendering:  
**UNIT Studio**  
[www.unit-studio.it](http://www.unit-studio.it)

Fotolito:  
**Attilio Schiabel**  
[a.schiabel@gmail.com](mailto:a.schiabel@gmail.com)

Testi:  
**Daniele Varelli**  
[www.varelli.it](http://www.varelli.it)

Progetto grafico:  
**Michele Stefanato**  
[www.msgrafica.info](http://www.msgrafica.info)

Stampa:  
**Lithostampa s.r.l.**  
[www.lithostampa.it](http://www.lithostampa.it)



MOBILI METALLICI

Via L. Galvani, 8/10 - 33083 Chions (PN)

Tel. 0039 0434 635210 - Fax 0039 0434 635258

[www.astrastyl.it](http://www.astrastyl.it) - [info@astrastyl.it](mailto:info@astrastyl.it)

  
**MADE IN ITALY**